

TANDY 102 Owner's Manual

Cat. No. 26-3803



The FCC Wants You to Know . . . This equipment has been certified to comply with the limits for a Class B computing device, pursuant to Subpart J of Part 15 of FCC Rules. Only peripherals (computer input/output devices, terminals, printers, etc.) that are certified to comply with the Class B limits may be attached to this computer. Operation with non-certified peripherals is likely to result in interference to radio and TV reception. If this occurs, try relocating the receiving antenna, or relocating the computer.

Tandy® 102 Software:

© 1985 Microsoft Incorporated.
All Rights Reserved.

The software in the Tandy 102 microcomputer is retained in a read-only memory (ROM) format. All portions of this software, whether in the ROM format or other source code form format, and the ROM circuitry, are copyrighted and are the proprietary and trade secret information of Tandy Corporation and Microsoft. Use, reproduction or publication of any portion of this material without the prior written authorization by Tandy Corporation is strictly prohibited.

Tandy® 102 Owner's Manual

© 1985 Tandy Corporation
All Rights Reserved.

Reproduction or use, without express written permission from Tandy Corporation and/or its licensor, of any portion of this manual is prohibited. While reasonable efforts have been taken in the preparation of this manual to assure its accuracy, Tandy Corporation assumes no liability resulting from any errors or omissions in this manual, or from the use of the information contained herein.

To Our Customers

Congratulations on purchasing the Tandy 102—a truly revolutionary portable computer!

This manual shows how to get started with the Tandy 102 and do many of today's most exciting and practical applications:

Part 1 shows how to start up the Tandy 102 and use all 5 of its built-in programs.

Part 2 shows how to communicate with public-access computers, such as CompuServe and Dow Jones.

Part 3 shows how to communicate with private computers, such as an office computer or a time-sharing computer.

Please feel at ease with the Tandy 102. Pressing the wrong key or typing the wrong information does no damage to a computer. You can usually correct a mistake simply by typing the information again correctly. If this does not work, turn to "Help" in the back of this manual.

Contents

<i>Part 1/ Using the Tandy 102</i>	1
1/ Starting Up	3
2/ Writing Notes and Letters (TEXT)	9
3/ Cutting, Pasting, and Finding Text (TEXT)	15
4/ Finding Schedules and Addresses (SCHEDL and ADDRSS)	21
5/ Dialing Telephone Numbers (TELCOM)	25
6/ Running BASIC Programs (BASIC)	29
7/ Expanding the Tandy 102	33
 <i>Part 2/ Communicating with Public-Access Computers</i>	 37
8/ Subscribing to Public Computer Services.....	39
9/ Accessing Public Computer Services.....	45

10/ Retrieving Information— A Sample Session with CompuServe	55
11/ Sending Electronic Mail— A Sample Session with CompuServe	61
12/ Using Public Bulletin Boards	65
13/ Automatically Dialing and Logging On.....	69
<i>Part 3/ Communicating with Private Computers</i>	<i>75</i>
14/ Which Computers can Communicate with TELCOM.....	77
15/ Setting Communication Parameters	85
16/ Establishing a Connection— Using the Built-in Modem	89
17/ Establishing a Connection— Using a Direct Cable	95

18/ Establishing a Connection— Using an External Modem	99
19/ Communicating and Exchanging Files	103
<i>References</i>	109
Reference A/ Help	110
Reference B/ TEXT Special Features	115
Reference C/ Memory Required by TEXT Paste Buffer	119
Reference D/ BASIC Programs	120
Reference E/ Tandy 102 Technical Information	122
Reference F/ TELCOM Codes	127

Part 1/

Using the Tandy 102

In this part of the manual, you will learn how to start the Tandy 102, how to immediately begin using its 5 built-in programs, and where to find additional programs, equipment, and information on the Tandy 102. We suggest that all customers read this part.

Chapter 1/ Starting Up

This chapter shows how to start the Tandy 102 and enter programs. You will need the Tandy 102 power adapter (Cat. No. 26-3804) or 4 Size AA alkaline batteries.

Starting the Tandy 102

1. Turn on the Memory Power Switch:

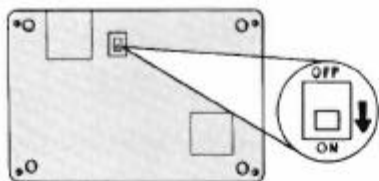

Never turn this switch off. Doing so causes you to lose all information you have stored in the Tandy 102.

2. Supply electric or battery power:

If using electricity, connect the Tandy 102 to an electric outlet, using the Tandy 102 power adapter. (Use only the Tandy 102 power adapter!)



If using batteries, insert them as shown:

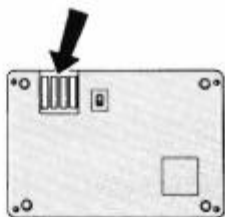

3. Turn on the Power Switch, and adjust the DISP dial to your field of vision:



Battery power lasts 14 hours. When the red battery indicator turns on, you have about 20 minutes of battery power left:



Using the Main Menu

On your screen is a menu similar (but not identical) to this:

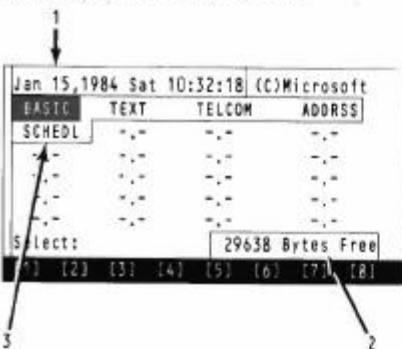

Note: If you do not see this menu, press (FB), the spacebar, or (SHIFT) and (BREAK) at the same time to “return” to it.

This is the Main Menu. It gives you this information:

1. Today’s date and time. You will set this later in this chapter.
2. The number of *bytes* (characters) remaining in *random access memory* (called RAM, for short).
3. The 5 program files that come with the Tandy 102—BASIC, TELCOM, ADDRSS, SCHEDL, and TEXT. These are built in to the Tandy 102’s *read-only memory* (ROM) and will remain in memory permanently.

The remaining spaces are empty now but will contain the names of the files (programs or data) you store in RAM. You have room to store 19 files in RAM.

Entering a File

The file in reversed characters is ready to enter. “Move” to other files by pressing the arrow keys (at the top of the keyboard).

Move to BASIC. Then “enter” it. (Press the (ENTER) key.) You see BASIC’s startup message:

```
TRS-80 Model 100 Software
Copr. 1983 Microsoft
29382 Bytes Free
OK
```

“Exit” BASIC by pressing (FB) (at the top of the keyboard).

Move to, enter, and exit 2 other files—TEXT and TELCOM—using the same keys: the arrow keys, (ENTER), and (FB).

Another way to enter a file is to simply type the name of a file and press (ENTER). As you type the filename, you can see the characters you are typing at “Select:”, which is at the bottom of the Main Menu. If you hear a beep, you have typed too many characters. Press (ENTER) and start over.

Setting the Clock and Calendar

Enter BASIC. Then press **(ENTER)**. Check the **(NUM)** key at the bottom of your keyboard; if it is pressed, release it.

Enter today's day: Use the format `DAYS="day"`, with "day" abbreviated—MON, TUE, WED, THU, FRI, SAT, or SUN. For example, if today is Tuesday, type:

`DAYS="TUE" (ENTER)`

(To produce uppercase letters, use **(SHIFT)** or **(CAPS LOCK)**, just as you would on a normal typewriter.)

Enter today's date: Use the format `DATES="mm/dd/yy"`. For example, if today is March 4, 1985, type:

`DATES="03/04/85"
(ENTER)`

Enter the time: Use the format `TIMES="hh:mm:ss"`, with military hours. For example, if it is now 4:03 p.m. and 15 seconds, type:

`TIMES="16:03:15" (ENTER)`

If you get an error message: Perhaps you omitted the quotation marks, omitted a leading 0, or used a wrong abbreviation.

Press **(ENTER)**. Then type the day, date, or time again correctly.

When finished: Check to be sure that BASIC stored the correct day, date, and time. Type:

`PRINT DAYS (ENTER)
PRINT DATES (ENTER)
PRINT TIMES (ENTER)`

Return to the Main Menu (by pressing **(FB)**), and you see the current day, date, and time.

Turning Off the Tandy 102

When finished using the Tandy 102, simply turn off the Power Switch (but be sure to leave the Memory Power Switch on). If you forget to turn off the power, the Tandy 102 waits 10 minutes and then turns it off for you. When this happens, you can turn the power on again by turning the Power Switch off and then back on.

Keeping Information Safe in Memory

The next chapters show how to store information in the Tandy 102's RAM. The Tandy 102's internal battery keeps this information in RAM even when the power is off. Make sure this internal battery never dies:

- Never turn off the Memory Switch on the bottom of the Tandy 102. This turns off the internal battery. We suggest that you put tape over this switch so nobody turns it off:

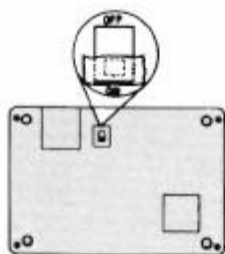

- If you need to let the Tandy 102 sit idle for more than 5-15 days, be sure that it has batteries in it and that these batteries are not dead. The Tandy 102's internal battery needs some kind of power source so that it can keep itself charged.

Using a Printer

Note: If you do not have a printer, skip to the next chapter.

You can use most any Radio Shack "parallel" printer with the Tandy 102. To connect it, you need to purchase the Tandy 102 printer cable (Cat. No. 26-1409).

Unpack your printer. Refer to your printer's owner's manual for instructions on:

- Inserting a ribbon
- Inserting paper
- Turning on the printer's power
- Turning the printer online

Turn all equipment off. Then make these connections:

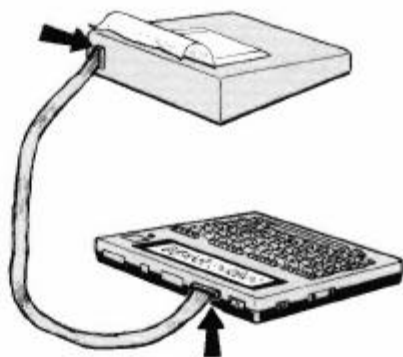

Do not force the connections; they work only 1 way. If they are difficult to make, you may have the cable upside-down.

Turn all equipment on and turn the printer online. Then press the **PRINT** key (at the keyboard top). The printer prints what is on your screen. In later chapters you will learn more uses of the printer.

Chapter 1 Summary

Tandy 102

To print the screen: Press **PRINT**.

To enter the "all caps" mode: Press **CAPS LOCK**.

Main Menu

To enter a file: (1) Move to the file and press **ENTER** or (2) Type the name of the file and press **ENTER**.

To move to a file: Use the arrow keys.

BASIC

To enter the day, date and time: Use the **DAYS**, **DATES**, and **TIME\$** commands.

*Note: Each chapter lists functions you might want to remember. Tandy 102 functions (such as **PRINT** or **NUM**) work the same no matter what program you are using. Other functions (such as the arrow keys) might work differently with each program.*

Chapter 2/

Writing Notes and Letters (TEXT)

In this chapter, you will create a “text” file. You will learn how to store notes, letters, sales orders, or any information in this file and, if you have a printer, how to print the information.

Creating a Text File

Assume you want to create a text file to store seminar notes. To create the file, enter the TEXT program. TEXT asks:

File to edit?

Enter a name for a file that has 6 or fewer characters and starts with a letter. For example, type **SEMINR** **(ENTER)**.

TEXT creates a file named SEMINR. You see a blank screen with a back arrow and a blinking box.

The back arrow is the end of the file. The blinking box (called the "cursor") is your position in the file.

Entering Text

Release the **(NUM)** key if it is pressed to get out of the "numeric keypad" mode. You may also need to release **(CAPS LOCK)** to get out of the "all caps" mode.

Then type these notes letting the words "wrap" from one line to the next. (The only time you need to press **(ENTER)**, the carriage return, is when you must end a line, such as the end of a paragraph.)

"Use of Portable Computers at Customer Locations,"
Computer Seminar, June 15,
1984: (ENTER)

1. Enter orders **(ENTER)**
2. Transmit orders to main computer **(ENTER)**
3. Access timesharing computer **(ENTER)**

Note how TEXT adjusts the words that wrap to the next line. You see this on your screen:

```
'Use of Portable Computers at Customer
Locations,'" Computer Seminar, June 15,
1984:◀
1. Enter orders◀
2. Transmit orders to main computer◀
3. Access timesharing computer◀
<-
[1] [2] [3] [4] [5] [6] [7] [8]
```

To correct mistakes: Use the **(BKSP)** key (at the top, right corner). It backspaces and erases.

To insert text: Using the arrow keys, move the cursor to position at which you want to insert text; then type your insertion. For example, move the cursor up to the "U" in "Use" and type **Reps**. TEXT adjusts your text accordingly:

```
'Reps Use of Portable Computers at
Customer Locations,'" Computer Seminar,
June 15, 1984:◀
1. Enter orders◀
2. Transmit orders to main computer◀
3. Access timesharing computer◀
<-
[1] [2] [3] [4] [5] [6] [7] [8]
```

To delete text: Move the cursor on top of the character you want deleted; then press **(SHIFT)** **(DEL)**. For example, move to the "1" in "June 15" and delete it by pressing **(SHIFT)** and then **(DEL)** at the same time. (**(DEL)** is actually a shifted **(BKSP)** key.)

```
'Reps Use of Portable Computers at
Customer Locations,' Computer Seminar,
June 5, 1984:◀
1. Enter orders◀
2. Transmit orders to main computer◀
3. Access timesharing computer◀
<-
[1] [2] [3] [4] [5] [6] [7] [8]
```

To repeat text: Press a key and hold it down for a while. **TEXT** repeats the key, over and over.

You may be repeating characters faster than **TEXT** can process them. You then discover that **TEXT** "remembers" what you type. You see **TEXT** "catch up" with you even after you finish.

To turn on the numeric keypad: Press **(NUM)**. The right keys are now numeric. To "turn off" the numeric keypad, press **(NUM)** again.

Entering and Exiting a Text File

To exit the text file and return to the Main Menu, press **(F8)**. The Main Menu shows the name of the file you created—**SEMINR.DO**. The **.DO** extension tells you that **SEMINR.DO** is a **text** file—not a program.

Also note that you now have fewer bytes free. This is because of the memory consumed by **SEMINR.DO**.

Now re-enter **SEMINR.DO**. (Move to **SEMINR.DO** and press **(ENTER)**.) You see the information still there—just as you left it.

Try turning the Tandy 102's power off and then on again. The information that you store in the Tandy 102 remains safe—even when the power's off—and will remain safe as long as you follow the precautions listed in Chapter 1.

Printing a Text File

In Chapter 1, you learned how to print a display by pressing **(PRINT)**. To print an entire text file, such as **SEMINR.DO**, you need to enter the text file and press **(SHIFT)** **(PRINT)**.

Enter **SEMINR.DO**. Press **(SHIFT)** and **(PRINT)** at the same time. **TEXT** asks for a width.

Type the number of characters you want printed on each line (a number between 0 and 132) and press **(ENTER)**. The **TEXT** program should then print **SEMINR.DO** on the printer.

If you decide not to print, press **(SHIFT)** and **(BREAK)** at the same time.

(**(BREAK)** is at the upper left corner.) No matter what program you are using, **you can always use (SHIFT) (BREAK) to cancel the current operation.**

Saving a Text File on Tape

Using tape, you can store endless numbers of files: large files, old files, infrequently-used files, and backup files of important information. By storing these files on tape, you can use the Kill function (described later in this chapter) to free up RAM space for the files you use every day.

We recommend you use Radio Shack's computer recorder (Cat. No. 26-1384), which includes a recorder-to-computer cable (Cat. No. 26-1207).

To connect the recorder: Plug in the 3-pronged end of the cable: the black plug to EAR, the large grey plug to AUX, and the small grey plug to REM. Connect the other end of the cassette connector to the back of the Tandy 102.

When finished, the connection should look like this:



To save a text file: Insert a blank tape in the recorder, and rewind it to the start. (If using a tape with a leader, forward the tape past the leader.) Press the recorder's **PLAY** and **RECORD** buttons until they lock. Select a file, then press **(F3)**, and **TEXT** prompts:

Save to:

Enter a filename using 6 or fewer characters; for example, type **SEMINR (ENTER)**. The recorder turns on, records, and then stops automatically. We recommend you store 2 or 3 copies of the file.

To protect a file: Once you have recorded a file on tape, you may want to *write-protect* the tape. To do so, remove the 2 notches on top of the tape:

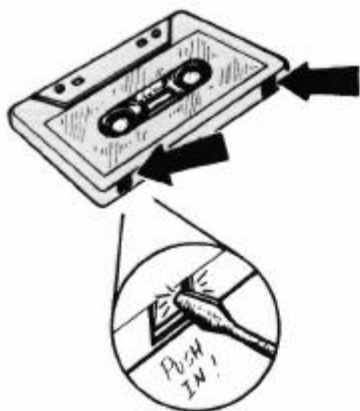

With the notches removed, you can load information from the tape, but you cannot record anything on it. If you ever want to cancel this write-protection, put some tape over the 2 notches.

To load a file: Rewind the tape and press the PLAY button until it locks. Set the volume between 4 and 6. Select a file, then press (F2), and TEXT prompts:

Load from:

In response to this prompt you can simply press (ENTER) (to load the next file) or type a filename and press (ENTER) (to load a specific file).

Type SEMINR (ENTER). TEXT turns on the recorder and, when it finds the SEMINR file, displays the message:

Found: SEMINR.DO

When the above prompt disappears, TEXT has finished loading SEMINR.DO into RAM.

Chapter 2 Summary

Tandy 102

To stop an operation: Press (SHIFT) (BREAK).

To turn on the numeric keypad: Press (NUM).

To turn off the numeric keypad: Release (NUM).

TEXT

To move the cursor: Use the (←) (→) (↑) (↓).

To move to the next line: Let the words "wrap" as you type, or press (ENTER).

To insert text: Move the cursor anywhere in the text and type.

To delete a character: Move the cursor on top of a character and press (SHIFT) (DEL).

To print a text file: Press (SHIFT) (PRINT), answer the width question, and press (ENTER).

To save a text file on tape: Press (F3); then type a filename.

To load a text file from tape: Press (F2); then type a filename.

Sample File

As an example of editing text, suppose you are a sales representative and want to update orders from customers' stores. Create a text file named ORDERS.DO and type the following orders:

```
ELM FURNITURE (ENTER)
pine tables (TAB) 15 (ENTER)
pine chairs (TAB) 5 (ENTER)
maple tables (TAB) 18 (ENTER)
(ENTER)
JONES FURNITURE (ENTER)
maple tables (TAB) 3 (ENTER)
pine cabinet (TAB) 5 (ENTER)
redwood shelves (TAB) 20 (ENTER)
(ENTER)
HANDY JOE (ENTER)
```

When you finish typing, you see only the bottom lines on your screen. The top lines are still in the file—they have simply “scrolled” off the top of the screen.

```

JONES FURNITURE◀
maple tables           3◀
pine cabinet           5◀
redwood shelves       20◀
◀
HANDY JOE◀
<-
(1) (2) (3) (4) (5) (6) (7) (8)
```

Using the Cursor Movement Keys

You have learned that you can move the cursor with the arrow keys. To move the cursor quickly, you can use a combination of an arrow key and a (SHIFT) or (CTRL) key.

- (SHIFT) (→) Moves to the right word
- (SHIFT) (←) Moves to the left word
- (CTRL) (→) Moves to the right of the line
- (CTRL) (←) Moves to the left of the line
- (SHIFT) (↑) Moves to the top of the display
- (SHIFT) (↓) Moves to the bottom of the display
- (CTRL) (↑) Moves to the top of the file
- (CTRL) (↓) Moves to the bottom of the file

Using the Edit Function Keys

To edit a file, use TEXT's function keys—(F1) through (F8)—at the top of the keyboard. To see what these keys do, press (LABEL) (also at the keyboard top). At the bottom of your screen, you see:

```
Find Load Save Copy Cut Sel Menu
```

Each function is above a number. For example, “Menu” is above the number 8. This tells you that you can return to the Main Menu with the (F8) key. You can turn this bottom line on and off with the (LABEL) key.

Finding Text

Suppose you want to quickly find all orders of "maple tables." First move to the start of the text. Then press the Find key (**F1**).

You see "String:" at the bottom of the screen. Enter the "string" of characters you want to find:

String: **maple tables** (**ENTER**)

You see TEXT quickly jump to the first occurrence of "maple tables":

```
ELM FURNITURE◀
pine tables      15◀
pine chairs     5◀
maple tables    18◀
◀
JONES FURNITURE◀
maple tables     3◀
Find Load Save List Copy Cut Sel Menu◀
(1) (2) (3) (4) (5) (6) (7) (8)
```

Find the next occurrence of the same string. Press (**F1**) and, to find the same string, simply press (**ENTER**).

Try to find a third occurrence of the string. TEXT prints "No Match". There are no more occurrences of "maple tables" in your text.

Selecting Text

Now suppose you need to, delete ("cut") Elm Furniture's order of "pine tables". To cut text, you first "select" what you want to cut:

1. Move to the start of the text you want to select. In this case, move to the "p" in "pine tables".

2. Press the Select key (**F7**). This puts you in the "select mode."

3. Select text using any of the cursor movement keys. In this case, press (**SHIFT**) (**←**) 3 times.

TEXT shows what you have just selected in reverse characters. If this is not the text you want, press (**SHIFT**) (**BREAK**) to cancel the operation and try it again:

```
ELM FURNITURE◀
pine tables     15◀
pine chairs     5◀
maple tables    18◀
◀
JONES FURNITURE◀
maple tables     3◀
Find Load Save List Copy Cut Sel Menu
(1) (2) (3) (4) (5) (6) (7) (8)
```

Cutting Text

With text selected, you can cut it simply by pressing the Cut key (**F6**). You see:

```
ELM FURNITURE◀
pine chairs     5◀
maple tables    18◀
◀
JONES FURNITURE◀
maple tables     3◀
pine cabinet    5◀
Find Load Save List Copy Cut Sel Menu
(1) (2) (3) (4) (5) (6) (7) (8)
```

Pasting Text

When you cut text, it is actually transferred to an area of memory called the “paste buffer.” With the **(PASTE)** key (at the top of the keyboard), you can “paste” this text anywhere you want.

Paste the text into Jones Furniture’s order. Move to the “r” in “redwood.” Then paste the text in place by pressing **(PASTE)**

```
maple tables      18◀
◀
JONES FURNITURE◀
maple tables      3◀
pine cabinet      5◀
pine tables       15◀
redwood shelves   20◀
Find Load Save List Copy Cut Sel Menu
(1) (2) (3) (4) (5) (6) (7) (8)
```

Copying Text

Now suppose the next customer, Handy Joe, wants the exact “copy” of Jones Furniture’s order. First, select the text you want to copy. In this example:

1. Move just under the “J” in “Jones Furniture.”
2. Press **(F7)**.
3. Use the cursor movement keys to select the following text. (In this example, press **(CTRL)** **(←)** and then press **(←)** 4 times.)

```
◀
JONES FURNITURE◀
maple tables      3◀
pine cabinet      5◀
pine tables       15◀
redwood shelves   20◀
◀
Find Load Save List Copy Cut Sel Menu
(1) (2) (3) (4) (5) (6) (7) (8)
```

After selecting text, press the Copy key (**(F5)**) to copy the text into the paste buffer. Then move to where you want the copied text to be—in this example, just under the “H” in “Handy Joe”—and press **(PASTE)**:

```
◀
HANDY JOE◀
maple tables      3◀
pine cabinet      5◀
pine tables       15◀
redwood shelves   20◀
◀
Find Load Save List Copy Cut Sel Menu
(1) (2) (3) (4) (5) (6) (7) (8)
```

Copying Text to Other Files

The information you cut or copy into the paste buffer remains there even after you exit a file. Because of this, you can copy text from 1 file to another. For example, assume you want to copy some text from **ORDERS.DO** to **SEMINR.DO**:

1. Select a block of text from **ORDERS.DO** and cut (**(F6)**) or copy (**(F5)**) it into the paste buffer.
2. Enter **SEMINR.DO** and, at the position where you want the text inserted, press **(PASTE)**.

Clearing the Paste Buffer

Just like text files, the contents of the paste buffer consume memory. After cutting and pasting or copying and pasting a large block of text, less memory is available.

You can “clear” the paste buffer by replacing its contents with nothing. To do this, press (F7), the Select key, and then copy nothing into the paste buffer by pressing (F5), the Copy key. The paste buffer now contains nothing, which, of course, consumes no memory.

You may find the amount of memory consumed by the paste buffer to be somewhat confusing. If so, refer to Reference C.

Renaming a File

To change the name of a file, you can use the BASIC program's NAME command. Return to the Main Menu and enter the BASIC program. Then, after entering BASIC, press the (ENTER) key and type the NAME command using the format: NAME “oldname” AS “newname” (ENTER). For example, NAME “SEMINR.DO” AS “MEMO.DO” (ENTER). Be sure to type the complete filename, including the extension.

Deleting a File

To delete a file, you can use the BASIC program's KILL command. Return to the Main Menu and enter the BASIC program. Then, after entering BASIC, press the (ENTER) key and type the KILL command using the format: KILL “filename” (ENTER). For example, KILL “MEMO.DO” (ENTER). Again,

be sure to type the complete filename, including the extension.

Chapter 3 Summary

Tandy 102

To turn on and off the function-key display: Press (LABEL).

TEXT

To move to the next word: Press (SHIFT) and (→) or (←).

To move to the beginning or end of the line: Press (CTRL) and (→) or (←).

To move to the top or bottom of the screen: Press (SHIFT) and (↑) or (↓).

To move to the top or bottom of the file: Press (CTRL) and (↑) or (↓).

To find text: Press (F1); then enter what you want to find.

To select text: Press (F7); then use the cursor movement keys.

To cut text: Select text and press (F6).

To copy text: Select text and press (F5). Then move to where you want it copied, and press (PASTE).

To copy a file: Use the same method described above for copying text.

BASIC

To rename a file: Use the NAME command.

To delete a file: Use the KILL command.

Using SCHEDL with NOTE.DO

The SCHEDL program selects "records" from a file named NOTE.DO. So before using SCHEDL, you need to create NOTE.DO. Use TEXT, as you have done in previous chapters, to create NOTE.DO; then insert these records:

```
9/18/85, product schedules due◀
10/18/85, announcement due◀
11/01/85, 10:30, New York flight, United
Airlines◀
10/05/85, 4:45, return flight, American
Airlines◀
11/07/85, proposal due◀
<-
(1) (2) (3) (4) (5) (6) (7) (8)
```

A record is any text—a word, line, paragraph, or even an entire file—that ends with **(ENTER)**. The above file has 5 records. Your records can be in any format. The above records are just 1 example.

Once you have created NOTE.DO, you can use SCHEDL to select records from it. Return to the Main Menu and enter SCHEDL. SCHEDL, like all Tandy 102 programs, shows all its functions on the bottom line. Also like all Tandy 102 programs, SCHEDL lets you use **(LABEL)** to turn on and off the bottom line.

To select records, press the Find key **(F1)** and tell SCHEDL which records you want to find. For example, press **(F1)**; then type **due (ENTER)**:

Schd: Find **due (ENTER)**

SCHEDL selects all the records in NOTE.DO that have the word "due":

```
Schd: Find due◀
9/18/85, product schedules due
10/18/85, announcement due
11/07/85, proposal due
Schd:
Find Lfnd Menu
(1) (2) (3) (4) (5) (6) (7) (8)
```

Try using other words to find records: **10/**, **product**, and **flight**. If SCHEDL cannot display all the records on one screen, it asks:

More Quit

Press the More key **(F3)** or **(M)** to see the next display or the Quit key **(F4)** or **(Q)** to quit the selection.

If you have a printer, you can use the Lfnd key **(F5)** rather than the Find key. SCHEDL prints your selected information on the printer.

Using ADDRSS with ADRS.DO

ADDRSS selects records from a file named ADRS.DO, rather than NOTE.DO. Other than that, ADDRSS and SCHEDL work the same.

For example, using TEXT, create a file named ADRS.DO with these records:

```
Rick Schell :214/925-7993: 453 Red
River, Dallas, TX, 75229◀
Ellen Dunlap :312/374-4822: 916
Drummond, Chicago, IL, 65219◀
Joe Shmow :214/876-2222: 815 Maple,
Dallas, TX, 75219◀
<-
```

(1) (2) (3) (4) (5) (6) (7) (8)

As with NOTE.DO, it makes no difference what format you use for the records. However, by enclosing telephone numbers in colons (:), you will be able to autodial these numbers using the TELCOM program later in this manual.

To find addresses, return to the Main Menu and enter the ADDRSS program. Then find: **TX, 214, and Joe Shmow.**

Organizing Records

You can easily find information in NOTE.DO and ADRS.DO if the information in these files is consistent. You may want to try using symbols to tag information.

For example, in NOTE.DO, you may want to use an asterisk (*) to tag each critical date and a number sign (#) to tag each personal date:

```
10/03/85, 11:45, lunch with
Jones #
10/10/85, reviews due
10/18/85, announcement due *
```

Or, in ADRS.DO, you may want to use a code such as ****IN**** to tag the members of an insurance organization or ****PR**** to tag prospective clients:

```
Rick Schell :214/925-7993:
453 Red River,
Dallas, TX, 75229 **IN**
Ellen Dunlap :312/374-4822:
916 Drummond,
Chicago, IL, 65219 **PR**
Joe Shmow :214/876-2222:
815 Maple,
Dallas, TX, 75219 **IN**
```

You could then use the tags to find the information you need. For example, you could use ****PR**** to find all the prospective clients stored in ADRS.DO.

Chapter 4 Summary

SCHEDL and ADDRSS

To find records: Press (F1); then enter what you want to find.

To find and list records on the printer: Press (F5); then enter what you want to find.

Note: *SCHEDL finds records from NOTE.DO; ADDRSS, from ADRS.DO.*

Connecting to the Telephone

Open the packet containing the modem cable. Save the instructions for use later in this manual.

The modem cable consists of 2 cables. The beige cable connects the Tandy 102's built-in modem to the telephone line. This connection lets you autodial telephone numbers or communicate with other computers over the telephone line. Connect the beige cable as shown:

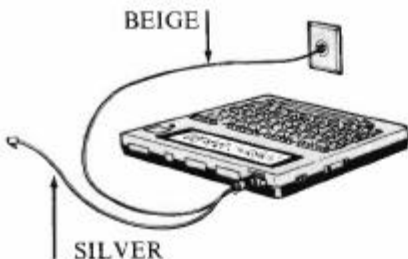

The silver cable connects the telephone unit to the telephone line. This connection lets you use the telephone unit in the normal way. Connect the silver cable as shown:

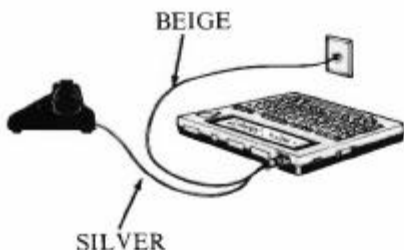

Set the DIR/ACP switch to DIR and the ORIG/ANS switch to ORIG:



The DIR setting tells TELCOM that the built-in modem is directly connected to the telephone. The ORIG setting tells TELCOM that the built-in modem will be originating, rather than answering, the call.

Enter TELCOM. TELCOM's bottom line gives the meaning of its function keys. As with the other programs, you can use **LABEL** to turn on and off this display.

Find Call Stat Term Menu

Setting TELCOM Parameters

TELCOM's top line gives its currently-set parameters. Most of these parameters are for communicating with another computer and will be discussed in Parts 2 and 3 of this manual. Only 2 of these parameters are important for autodialing:

M711E,10 pps

- The "M" tells TELCOM to use the built-in modem. (You must use the built-in modem to autodial.)
- The "10 pps" tells TELCOM to pulse dial at 10 pulses per second.

If your display shows different values for these 2 parameters, press the Status function key (**F3**) and enter the new value by typing **M711E,10 pps** (**ENTER**). Then press (**F3**) (**ENTER**) to see that you have set the parameters correctly.

Autodialing Numbers

Press the Call function key (**F2**) and you see "Call." Now type the number you want to call.

Examples:

555-1212
1-(214)-352-3535
9/555-1212

Be sure to include all digits required to dial the number. (For example, a "1" or "9" may be required). TELCOM ignores extra symbols, such as the hyphen (-) and the slash (/). As with other programs, you can use (**BKSP**) to correct mistakes.

Before pressing (**ENTER**), pick up the telephone receiver. Press (**ENTER**) and you hear TELCOM dial the number.

Finding and Autodialing Numbers

You can find and autodial a telephone number stored in **ADRS.DO** (Chapter 4) as long as you have enclosed it in colons (:). For example, assume **ADRS.DO** contains this number:

Joe Shmow :214/876-2222:
815 Maple,
Dallas, TX, 75219

To find and autodial this number:

1. Press the TELCOM FIND key (**F1**), and enter any part of the record you want to find. To find the record containing Joe Shmow, for example, you could enter **214, Dallas, TX,** or **Joe:**

Telcom: Find **Joe** (**ENTER**)

TELCOM displays the first record that contains these characters. Example:

Joe Shmow :214/876-2222

2. At the bottom of the screen TELCOM asks whether you want to call (Call), find the next record containing these characters (More), or quit finding records (Quit):

Call More Quit

Since this is the record containing the number you want to dial, press Call (**F2**). TELCOM shows the number as it dials.

3. Before TELCOM finishes dialing, pick up the telephone receiver—Otherwise, the connection will be broken.

Fast Pulse Dialing

By dialing at 20 pps (20 pulses per second), you can dial numbers twice as fast. Press the Stat key (**F3**) and change the 10 pps to 20 pps:

M711E,20 pps **ENTER**

(As stated earlier, you can press **F3** **ENTER** to check that you have entered the parameters correctly.) Your local telephone system may not be able to use 20 pps. If not, change back to 10 pps.

Disconnecting from the Telephone

For convenience, you can disconnect the Tandy 102 from the modem cable, but still leave the modem cable connected to the telephone. If you do this, you need to complete the circuit that normally goes to the Tandy 102 by connecting it to the modem cable's "shorting" plug:



Chapter 5 Summary

TELCOM

To find and autodial a number: Press **F1**, enter any part of a record in ADRS.DO, and press **F2** to call.

To enter and autodial a number: Press **F2** and enter the number.

To reset communication parameters: Press **F3**; then enter the new parameters.

To display the current communication parameters: Press **F3** **ENTER**.



Chapter 6/

Running BASIC Programs (BASIC)

This chapter shows how to type and run simple programs, using the BASIC programming language.

Entering BASIC

Enter BASIC from the Main Menu in the same way you entered the other programs (by moving to BASIC and pressing **ENTER**). On the last line of the BASIC start-up message, you see BASIC's prompt:

Ok

Press the **LABEL** key and you see the meaning of BASIC's function keys on the bottom of the screen.

Typing and Running a BASIC Program

Before typing a program, erase anything you may have accidentally stored in BASIC's memory. Press **ENTER**; then type:

NEW **ENTER**

Now type this simple BASIC program exactly as shown:

```
10 CLS ENTER
20 PRINT @ 55, "HELLO!"
ENTER
30 PRINT @ 122, "I SEE
WE SPEAK THE SAME
LANGUAGE ....." ENTER
40 PRINT @ 210,
"BASICALLY SPEAKING."
ENTER
```

When you run this program, the CLS command will clear the screen. The PRINT @ command will tell BASIC to display text on the screen at the specified position.

To see if you have entered all the lines in this program correctly, press the List function key (**F5**). If you typed a line incorrectly, simply press **ENTER** and type it again correctly. When finished typing the program, press **ENTER**.

Test the program by pressing the Run function key (**F4**). Your screen shows:

```
HELLO!
I SEE WE SPEAK THE SAME LANGUAGE .....,
BASICALLY SPEAKING.
Ok
File Load Save Run List Menu
(F1) (F2) (F3) (F4) (F5) (F6) (F7) (F8)
```

Saving a BASIC Program

To save the program in RAM, press the Save function key (**F3**). BASIC displays:

SAVE "

Enter a name for the program. For example, type **HELLO** **ENTER**.

Return to the Main Menu (by pressing **F8**) and you see a new file—HELLO.BA—on the menu. The .BA extension tells you that HELLO is a BASIC program.

You can run HELLO anytime you want by moving to HELLO.BA's position on the Main Menu and pressing **ENTER**.

Loading a BASIC Program

You might want to load a program back into BASIC so that you can revise and edit it. To do so, enter BASIC and press the Load function key (**F2**). BASIC displays:

LOAD "

Type HELLO (**ENTER**). Press the List key (**F5**) and you see that HELLO.BA is loaded into BASIC.

Editing a BASIC Program with TEXT

To edit a BASIC program, press (**ENTER**) and, type:

EDIT (**ENTER**)

This command loads the BASIC program into TEXT. You can now edit the BASIC program, just as you edit a TEXT file. When finished editing, press (**F8**), and the program is loaded back into BASIC.

Learning More About BASIC

Many books are available in computer stores that teach how to program in BASIC. You can use any of these books to learn how to program and use the *Tandy 102 Applications and BASIC Reference Guide* to learn which BASIC commands the Tandy 102 uses.

Chapter 6 Summary

BASIC

To erase BASIC memory: Type NEW (**ENTER**).

To list a BASIC program: Press (**F5**).

To run a BASIC program: Press (**F4**).

To save a BASIC program: Press (**F3**); then enter a filename.

To load a BASIC program: Press (**F2**); then enter a filename.

To edit a BASIC program: Type EDIT (**ENTER**). (Return to BASIC by pressing (**F8**.)

Tandy 102 Equipment

The Tandy 102 lets you connect any of the following equipment:

- *AC adapter.* You can conserve your batteries by using the AC adapter (Cat. No. 26-3804).
- *A printer.* You can get a hardcopy of information as shown in this manual by using most any Radio Shack or Tandy parallel printer that is Centronics-compatible.
- *A cassette recorder.* You can increase your storage capacity as shown in this manual by using any cassette recorder—we recommend our computer recorder (Cat. No. 26-1384) which comes with the required cable (Cat. No. 26-1207).
- *A portable disk drive.* You can store up to 200k of data on standard 3 1/2" floppy diskettes. This unit is battery powered for complete portability including the connecting cable (Cat. No. 26-3814).
- *A bar code reader.* You can optically scan product code labels by adding the Tandy Bar Code Reader (Cat. No. 26-1183).
- *A disk/video interface.* You can expand the use of the Tandy 102 to that of a larger computer by purchasing the Tandy Disk/CRT display unit (Cat. No. 26-3806). This gives you one 5 1/4" floppy disk drive and can be attached to a normal television display or video monitor.
- *A direct connect modem cable.* You can directly connect the Tandy 102's built-in modem to the telephone as shown in Chapter 5 of this manual by using the Direct-Connect Modem Cable (Cat. No. 26-1410).
- *An acoustic coupler.* You can connect the Tandy 102's built-in modem to any telephone (even in a phone booth) as shown in Parts 2 and 3 of this manual by using the Acoustic Coupler (Cat. No. 26-3818).
- *An external modem.* In addition to the Tandy 102 built-in modem, you can also use an external modem. See Part 3 of this manual for more information.
- *Another computer.* You can directly connect to another computer that has an RS-232 connection interface by purchasing an RS-232 cable (Cat. No. 26-4403) and a null modem adapter (Cat. No. 26-1496). See Part 3 of this manual for information on how to do this.

Tandy 102 Programs

You can purchase many additional Tandy 102 programs that enhance the capabilities of the Tandy 102 built-in programs or let you do additional functions:

- ***Tandy-supported software.*** These programs are supported and supplied by Tandy. You can get a list of available programs at any Radio Shack Computer Center.
- ***Tandy express order software.*** These programs are supplied by Tandy, but supported by the vendors that developed the programs. You can also get a list of these programs at any Radio Shack Computer Center.
- ***Programs from other suppliers.*** These programs are supplied and supported by outside vendors. You can find out the programs that are available for the Tandy 102 by reading the portable computing magazines, described below.

You will normally be able to purchase programs either as ROM cartridges (which the Radio Shack service technician will plug into the bottom of the Tandy 102) or as cassette tapes (which you will need to load into RAM using a cassette recorder).

Please note that the Tandy 102 is fully compatible with the Model 100. Most all Model 100 programs will run on the Tandy 102.

Tandy 102 Information

For additional information on the Tandy 102, see the following publications:

- *The Tandy 102 Applications and BASIC Reference Guide*, which also comes with the Tandy 102.
- *Tandy 102 Technical Reference Manual*. This manual gives information on the Tandy 102 operating system calls as well as technical information on how to program the hardware.
- One available portable computer magazines is *PCM*, Falsoft, Inc., 9529 Highway 42, Prospect, Kentucky, 40059.

Part 2/

Communicating with Public-Access Computers

One of the most exciting uses of the Tandy 102 is to communicate with a public-access computer. This gives you access to overwhelming amounts of information and services. For example, by communicating with a public-access computer, you could access current news, financial quotations, and bulletin board services.

In this part of the manual, you will learn how to subscribe to and communicate with a public-access computer. If you are not interested in doing this, you can skip this part without feeling that you have missed any important information.

How Public Computer Services Work

Public computer services offer subscriptions to useful services, such as news and electronic mail, that can easily be accessed by small computers.

To access these services, you usually need to call the telephone number of a third party—a computer network. First you call and connect to the network. The network then “relays” a connection between you and the service.

Which telephone number you can use to make this connection depends on the service. Many services let you use the telephone numbers of large public networks—such as Tymnet® and Telenet®, in the United States, and Datapac, in Canada. These large networks consist of hundreds of local numbers all across the country.

After you connect to a service, you normally need to “logon.” This requires that you enter certain information—such as a password—that the service needs to give you. When finished using the service, you normally need to “logoff.”

CompuServe

CompuServe Information Service® is a large multi-purpose computer service. Its services include news, shopping, electronic mail, conferencing, bulletin boards, and financial quotations.

You can connect to CompuServe and use its services for 1 hour, free of charge, if you purchased the direct-connect modem cable (introduced in Chapter 5). To use this free hour, you need to find the following materials which come with the modem cable:

- A packet containing a CompuServe user ID and password—You can use this ID and password to access CompuServe for 1 free hour during “standard time” (6PM to 5AM).
- A pamphlet listing all the telephone numbers in the CompuServe Network—the CompuServe Network has telephone numbers in almost all the major U.S. cities; you can use any of these numbers to access CompuServe.

After finding these materials, you can immediately connect to and use your free hour with CompuServe. To do so, follow the instructions in the next chapter for accessing CompuServe and, in Step 7, use the CompuServe Network.

During your free hour, CompuServe will give you the opportunity to sign up for continued services. If you sign up for these services, CompuServe will start billing you only for the time you spend online (unless you use special services). At this writing, CompuServe's online charge is:

\$6.00/hour—standard time

\$12.50/hour—prime time

(This is CompuServe's charge for using a 300-baud telephone line, which is the only kind of line you can use with the Tandy 102 built-in modem.)

After signing up for continued services with CompuServe, CompuServe lets you access it through 3 large, public networks—Telenet, Tymnet, or Datapac—as an alternative to using the CompuServe network. You might want to use a large public network if the CompuServe Network does not have a local number in your area.

To find out if any of the public networks has a local number in your area, call CompuServe—(800/848-8199 or, in Ohio, 614/457-0802). Then, whenever you want to use the public network to access CompuServe, simply call the number of the public network, rather than CompuServe, and connect to CompuServe using the public network, as instructed in the next chapter.

When you use a public network to connect to CompuServe, CompuServe will add the network's cost to your bill. At this writing, CompuServe's added charges for using Telenet or Tymnet are \$2.00/hour—standard time and \$10.00/hour—prime time.

When you access CompuServe through Datapac, you need to go through an intermediary network: Telenet, Tymnet, or CompuServe. CompuServe's added charge for using Datapac through Telenet are \$10.50/hour, its added charge for using Datapac through Tymnet are \$9/hour, and its added charge for using Datapac through CompuServe are \$5.20-\$9.20/hour. These charges apply to standard and prime time.

Dow Jones

Dow Jones News Retrieval® Service is a general-purpose computer service that specializes in financial data. Its financial data includes news, financial quotations, corporate earning estimates, company disclosures, weekly economic survey/updates, and *Wall Street Journal* highlights.

If you purchased the direct-connect modem cable, you can subscribe to Dow Jones and use its services for 1 hour, free of charge. Dow Jones will then

charge you only for the time you spend online with it—You can get a list of these charges during your free hour with Dow Jones, as described below.

To subscribe to and immediately start using your free hour with Dow Jones, call Dow Jones (800/257-5114 or, in New Jersey or Canada, call 609/452-1511). You will need to give a “control number.” This control number is on the upper right-hand corner of a Dow Jones form that comes with the direct-connect modem cable.

Dow Jones will give you (1) a password, and (2) a telephone number of a network. At this writing, Dow Jones lets you connect to it through 3 networks—Tymnet, Telenet, and Datapac—and includes the costs of these 3 networks in its rate structure.

After getting this information, connect to Dow Jones and get an introduction to its services, as instructed in the next chapter. Dow Jones will send you a well-documented manual on how to use all of its services.

*The Source*SM

The Source is a large multi-purpose computer service. Its services are similar to those offered by CompuServe. One reason you may want to subscribe to The Source is to use its electronic mail service, called Source Mail.

Unlike CompuServe's electronic mail service (Chapter 11), Source Mail places no limits on how large a document you can send.

The Source charges \$100 to subscribe and a minimum monthly charge, at this writing, of \$10. For basic online services in the continental United States, the Source charges \$20.75/hour prime time and \$7.75/hour non-prime time.

To subscribe, call 800/336-3366 and get (1) a user ID, (2) a password, and (3) a telephone number of a network. At this writing, The Source lets you connect to it using 3 networks—Telenet, Uninet, and Datapac—and includes the cost of these networks in its rate structure.

You can then connect to The Source as instructed in the next chapter. The Source uses menus that are easy to understand and will also send you a well-documented manual on how to use its services.

Other Services

CompuServe, Dow Jones, and The Source are just a few of many public services. The following lists the kinds of services available. (To get a complete listing of public computer services, use an online directory such as the *Omni Online Data Base Directory*, published by MacMillan Publishing Company.)

- **News Services.** You can get comprehensive news by connecting to networks such as Newsnet (945 Haverford Road, Bryn Mawr, PA, 19010). Newsnet has about 200 newsletters from 30 different industries in its data bank.
- **Library Services.** You can access massive encyclopedia data bases by connecting to networks such as DialogSM Information Services (3460 Hillview Ave., Palo Alto, CA, 800/227-1927 or, in California, 800/932-5838), BRS Bibliographic Retrieval Services (1200 Route 7, Latham, NY 12110), and Orbit Information Retrieval Services (SDC Search Service, 2500 Colorado Ave, Santa Monica, CA 90406, 800/421-7229 or, in California, 800/352-6689).
- **Special Interest Networks.** You can access special data bases by connecting to networks such as Westlaw (West Publishing Company, 58 W. Kellogg Blvd., P.O. Box 43779, St. Paul, MN, 612/228-2429).
- **Hardcopy Electronic Mail Networks.** You can send electronic mail to a city and then have the mail printed and delivered by connecting to services such as MCI Mail Service (2000 M Street NW, Washington, DC, 20036, 800/624-2255) and the U.S. Postal ECOM[®] Service (available through The Source, which is described above).
- **Telex Networks.** You can send telexes as electronic mail by connecting to services such as ITT[™] Timetran, RCA Global Communications (201 Centennial Ave., Box KC-8, Picataway, NJ, 08854, 800/526-3969) and Western Union Easylink (One Lake St., Upper Saddle River, NJ, 07458, 800/336-3797).

To use one of these services you need to contact the service, subscribe to it, and obtain the following information:

- The word length, parity, stop bit, and start/stop (XON/XOFF) enablement parameters to use when communicating with the service.
- The telephone number of a network you can use to connect to the service. Unless you use an external modem (discussed in Part 3 of this manual) that is capable of transmitting at a higher rate of speed, you can use only a number that transmits at a speed of "300-baud."
- The instructions for how to access, logon, and logoff the service.

You can then connect to the service, using the next chapter as your guide.

Connecting to a Computer Network

To connect to a computer network, you need a way of connecting the Tandy 102's built-in modem to an ordinary telephone. You can use either:

- The direct-connect modem cable (Cat. No. 26-1410) that you used in Chapter 5 of this manual—This is the most reliable because it connects the built-in modem directly to the telephone wire.

or

- An acoustic coupler (Cat No. 26-3818)—Use this when you cannot directly connect to a telephone (for example, when using a pay phone).

1. Set TELCOM's Parameters

You see TELCOM's parameters when you first enter TELCOM. Unless you are autodialing, you do not need to be concerned with the last parameter—10 pps or 20 pps—but the others must be:

CompuServe: M7E1E
Dow Jones: M7E1D
The Source: M7E1E
Other Services: See instructions later in this chapter.

If you need to reset the parameters: Press (F3) and enter the new value. Example: (F3) M7E1E (ENTER). Then display the new value by pressing (F3) (ENTER).

2. Connect to the telephone

Modem Cable: Connect the Tandy 102 built-in modem to the telephone line as you did in Chapter 5. Be sure the DIR/ACP switch (on the left of the Tandy 102) is set to DIR, for "direct-connect."

Acoustic Coupler: Connect the acoustic coupler to the Tandy 102 PHONE jack (on the rear of the Tandy 102) and set the DIR/ACP switch (on the left of the Tandy 102) to ACP, for "acoustic coupler."

3. Set to "originate."

Set the ORIG/ANS switch (on the left of the Tandy 102) to ORIG, for "originating the call."

4. Call the network.

The computer service should have supplied you with a telephone number of a network that you can use to access the service. (See the last chapter if you do not have this telephone number.)

Dial this number. If using the modem cable, you can dial any way you want—manually or automatically. If using the acoustic coupler, you can dial only 1 way—manually.

5. Enter TELCOM's terminal mode.

When the network answers the phone, you hear a high-pitched tone. Press Term (**F4**). If using the acoustic coupler, place the phone in the coupler:



6. Wait for TELCOM's terminal function-key display

A few seconds after you press **F4** TELCOM establishes a terminal connection with the network and shows these functions on the bottom of your screen:

Prev Down Up Full Bye

If these functions do not appear, TELCOM has not established a connection. Hang up the telephone and try again. Check that you have the right TELCOM parameter settings, telephone connections, and ACP/DIR settings.

Also check the telephone number you are using. Some networks have different telephone lines. You can use only a "300-baud" line.

Now, turn to the section on "Accessing CompuServe," "Accessing Dow Jones," or "Accessing The Source." These sections give specific instructions on how to access, logon, use, and logoff the services provided by CompuServe, Dow Jones, and The Source.

If you want to use a service other than CompuServe, Dow Jones, or The Source, you need to use the instructions that the service has given you.

Accessing CompuServe

7. Access the CompuServe Services

Follow the instructions below for accessing CompuServe through the specific network that you are using. When you see the CompuServe "User ID" prompt, go to Step 8, "Logon to CompuServe."

Using the CompuServe network: Simply press **CTRL****C** (Hold down **CTRL** while pressing **C**.)

Using Tymnet: Tymnet will give you 2 prompts. Respond to the first by typing **A** (Do not press **ENTER**.) The second prompt might have many meaningless characters. Respond to it by pressing **CTRL****P**. (Hold down **CTRL** while pressing **P**.) Then enter one of these symbols: **CIS02**, **CIS03**, **CIS04**, **CPS01**.

Example:

please type your terminal
identifier: **A**

please log in: **CTRL** **P**
CPS01 **ENTER**

Using Telenet: Immediately after establishing a terminal connection with Telenet, press the **ENTER** key twice. Telenet will then give you 2 prompts. Respond to the first by entering **D1**. Respond to the second by entering one of these symbols: **C 202202** or **C 614227**.

Example:

ENTER **ENTER**
TERMINAL = **D1** **ENTER**
@C 202202 **ENTER**

Using Datapac: Immediately after establishing a terminal connection with Datapac, press **ENTER**. Datapac will display a message similar to **DATAPAC:9999 9999**. Enter one of these codes, depending on which network you want to use as an intermediary network: **P 29400138** (CompuServe), **P 13106,CPS** (Tymnet), or **1311061400227** (Telenet). Then, if prompted for a host name, enter **CIS**. Example:

ENTER
DATAPAC:9999 9999
P 29400138 **ENTER**
Host Name: **CIS** **ENTER**

8. Logon to CompuServe

CompuServe will give you 2 prompts. Respond to the first by entering your unique user ID. Respond to the second by entering your unique password.

Example:

User ID: **76338,448** **ENTER**
Password: **SECRET** **ENTER**

9. Use the CompuServe Services

You should now be connected to the CompuServe Information Service. The next chapter shows how to use this service for the first time.

10. Logoff the CompuServe Services

You can logoff CompuServe in two ways. One way is to press **CTRL D**. (Hold down **CTRL** while pressing **D**.) The other way is to wait until you see the "!" prompt and then type **BYE** **ENTER** or **OFF** **ENTER**. (You can usually get to the "!" prompt by pressing **CTRL C**.) After logging off, go to the section in this chapter on "Disconnecting from a Computer Service."

Accessing Dow Jones

7. Access the Dow Jones Service

Follow the instructions below for accessing Dow Jones through the specific network that you are using. When you see the Dow Jones "WHAT SERVICE PLEASE?????" prompt, go to Step 8, "Logon to Dow Jones."

Using Tymnet: Tymnet will give you 2 prompts. Respond to the first by typing **A** (**Do not press ENTER**.) The second prompt might have many meaningless characters. Respond to it by pressing **CTRL P**. (Hold down **CTRL** while pressing **P**.) Then enter the symbol **DOW1;**; (The second ";" will not show on your screen.)

please type your terminal
identifier: **A**

please log in: **DOW1;**
ENTER

Using Telenet: Immediately after establishing a terminal connection with Telenet, press the **ENTER** key twice. Telenet will then give you 2 prompts. Respond to the first by entering **D1**. Respond to the second by entering the symbol **C 60942**:

ENTER ENTER
TERMINAL = D1 ENTER
@C 60942 ENTER

Using Datapac: Immediately after establishing a terminal connection with Datapac, press **000(ENTER)**. Datapac will display a message similar to **DATAPAC:9999 9999**. Type **13106,DOW1;;(ENTER)**.
Example:

```
000 (ENTER)
DATAPAC:9999 9999
13106,DOW1;; (ENTER)
```

8. Logon to Dow Jones

Dow Jones will give you 2 prompts. Respond to the first by entering **DJNS**. Respond to the second by entering your unique password. Example:

```
WHAT SERVICE
PLEASE?????? DJNS
(ENTER)
ENTER PASSWORD:
SECRET (ENTER)
```

9. Use the Dow Jones Services

You should now see some messages followed by the prompt "ENTER QUERY". This lets you know that you are connected to the Dow Jones News Retrieval Service. If you have not yet received a manual from Dow Jones, respond to this prompt by typing **//INTRO (ENTER)**:

```
ENTER QUERY
//INTRO (ENTER)
```

//INTRO gives an introduction to Dow Jones' services and lets you access a list of Dow Jones' current online charges. While using **//INTRO**, it may help to know that you can return to the main **//INTRO** menu at any time by typing **M (ENTER)**. It also may help to know that Dow Jones uses the word "RETURN" to refer to the **(ENTER)** key.

10. Logoff the Dow Jones Services

From wherever you are within the Dow Jones services, you can logoff by typing **DISC (ENTER)**. Then go to the section in this chapter on "Disconnecting from a Computer Network."

Accessing The Source

7. Access The Source Services

Follow the instructions below for accessing The Source through the specific network that you are using. When you see the The Source ">" prompt, go to Step 8, "Logon to The Source."

Using Telenet: Immediately after establishing a terminal connection with Telenet, press the (ENTER) key twice. Telenet will then give you 2 prompts. Respond to the first by entering **DI**. Respond to the second by entering the symbol **C 30147**:

```
(ENTER) (ENTER)
TERMINAL = DI (ENTER)
@C 30147 (ENTER)
```

Using Uninet: Uninet will give you 2 prompts. Respond to the first by typing (ENTER) (ENTER). Respond to the second by typing **S15** (ENTER):

```
? (ENTER) (ENTER)
service: S15 (ENTER)
```

Using Datapac: You need to contact The Source for instructions on how to access it through Datapac. These instructions vary according to your Source user ID.

8. Logon to The Source

The Source will give you 2 prompts. Respond to the first prompt simply by pressing (ENTER). Respond to the second by entering **ID** followed by your unique user ID and your unique password. Example:

```
> (ENTER)
ID USER999 SECRET
(ENTER)
```

9. Use The Source Services

You should now be connected to The Source. If you have not yet received a manual from The Source, you can still use The Source by following its menu prompts. The Source uses menus and prompts that are easy to understand.

10. Logoff The Source

At the command mode, type **OFF** (ENTER). (Depending on where you are within The Source, you can get to the command mode by pressing (CTRL) (P) or (CTRL) (C), or by typing **QUIT** (ENTER) or **STOP** (ENTER).)

Disconnecting from a Computer Network

Before disconnecting, be sure you have logged off the service. This way, the service will know to stop billing you for your online time. The previous sections in this chapter show how to logoff CompuServe, Dow Jones, and The Source.

Then, press **(F8)** and respond to TELCOM's "Disconnect?" prompt with **(Y)** **(ENTER)**. TELCOM exits its "terminal mode" and returns to its "interactive" function-key display:

Find Call Stat Term Menu

Press **(F8)** to return to the Tandy 102 Main Menu.

Determining TELCOM's Parameters for Connecting to Other Services

Use the following to determine how to set TELCOM's communication parameters when communicating with services other than CompuServe, Dow Jones, and The Source:

Mwpsx

The parameters that are in italics—such as *w* and *p*—need to match the parameters used by the computer service.

w is the word length.

TELCOM can use any of these parameters: 6, 7, or 8.

p is the parity. TELCOM can use any of these parameters: I (ignore), O (odd), E (even), N (none).

s is the stop bit. TELCOM can use either of these parameters: 1 or 2.

x is the start/stop (also called XON/XOFF) character enablement. TELCOM can use either of these parameters: E (enable start/stop characters) or D (disable start/stop characters).

For example, assume the service you subscribe to tells you that it uses the following parameters:

8-bit word length
no parity
1 stop bit
start/stop (or XON/XOFF)
disabled

The TELCOM parameters you need to use are:

M8N1D

Note: The meaning of all TELCOM's parameters are described in Chapter 15.

Chapter 10/

Retrieving Information—A Sample Session with CompuServe

This chapter is a sample session. The first part of this chapter shows how to retrieve information from CompuServe; the last part shows how to use some TELCOM keys that are useful when retrieving information from any computer service.

Your First CompuServe Session

Note: Although your session with CompuServe should closely resemble the one described in this chapter, do not expect it to be identical. CompuServe often revises or improves its menus and prompts.

CompuServe normally starts up with a "top menu." For your first session, though, CompuServe may ask preliminary questions.

After each question CompuServe typically shows a selection of responses and prompts you for your choice. For example:

- 0 Explanation of terminal types
- 1 VIDTEX software compatible
- 2 ANSI compatible (VT-100)
- 3 VT52
- 4 Teleray
- 5 CRT
- 6 Other

Key choice:

Notice in this example that you can choose "0" and CompuServe gives you instructions. CompuServe often offers "online instructions" such as these.

The following are some questions CompuServe may ask and how we suggest you respond.

- What kind of terminal do you have? Select "Other".
- How many lines does your terminal have? Select "8".
- How many characters per line does your terminal have? Select "40".
- Do you want to read or agree to CompuServe's service terms? Select the option that lets you "exit the service". (You can agree to the terms and sign up for continued service later, after becoming more familiar with CompuServe.)

In each case, type the appropriate menu selection number; then press **(ENTER)**. For example:

Key choice: 3 **(ENTER)**

If you make a mistake, use **(CTRL) (H)** to backspace. (The **(BKSP)** key does not work with CompuServe.) Press **(CTRL)** and then, while holding down **(CTRL)**, press **(H)**.

Seeing TELCOM's Previous Screen

Sometimes CompuServe's information may scroll off your screen faster than you can read it. When this happens, you can use one of TELCOM's terminal-mode function keys, the "previous screen" key (**(F1)**).

Press **F1** to see the previous screen; then **F1** again to return to the current screen. TELCOM keeps 2 screens in memory at all times.

CompuServe Menus

After its preliminary questions and messages, CompuServe displays a "top menu" similar to this:

1. Home Services
2. Business & Financial
3. Personal Computing
4. Services for Professionals
5. The Electronic Mall™
6. User Information
7. Index

Enter your selection number, or H for more information!

This menu leads you to a series of submenus. After each menu, you see the "!" sign, which is CompuServe's menu prompt. In response to the "!" prompt, you can enter your menu selection (for example, **I** **ENTER**) or a CompuServe command such as:

- **P** **ENTER**—to see the previous menu.
- **T** **ENTER**—to go back to the top menu.
- **BYE** **ENTER**—to exit CompuServe.

For example, typing **T** **ENTER** at the "!" prompt always returns you to the top menu or the first menu of the system.

From CompuServe's top menu, you can get anywhere within its data bases. For example, assume you want to get the latest business news stories. From the top menu:

- Choose the home services option and CompuServe displays a Home Services Menu.
- Choose the news/weather/sports option and CompuServe displays a News/Weather/Sports menu.
- Choose AP videotex wire option and CompuServe displays an AP Wire Menu.
- Choose the business news option and CompuServe displays a selection of business news stories.
- Choose a story and CompuServe displays your selected business news story.

Using CompuServe Pages

As you travel through CompuServe's menus, notice that CompuServe has each menu indexed with a page number. For example, the Home Services Menu is on page HOM-1; the News/Weather/Sports Menu is on page HOM-10.

Using CompuServe's GO command, followed by a page number, you can go directly to the page you need. For example, the News/Weather/Sports Menu is on page HOM-10; to go to this menu, type (at the "!" prompt) **GO HOM-10** **(ENTER)**:

! GO HOM-10 (ENTER)

To find the numbers for all CompuServe's pages, go to the CompuServe index. At the "!" prompt, type **GO IND** **(ENTER)**. Then select the option that lists all the indexed topics.

Notice that when you ask CompuServe to display a large volume of data, such as its index, it shows 1 page at a time. After each page:

- You can simply press **(ENTER)** to display the next page of data.

or

- In most cases, you can type **S** **(ENTER)** (CompuServe's "scroll" command) to scroll continuously through the remaining pages of data.

Using TELCOM's Start/Stop Keys

Before logging on to CompuServe, you set your communication parameters to M7E1E. The 5th parameter ("E") causes TELCOM to "enable" a protocol that CompuServe and many

other computers use: the "start/stop" protocol.

The start/stop protocol gives a special meaning to these characters:

- **(CTRL) (S)**—a "stop transmission" character (also called "XOFF")
- **(CTRL) (Q)**—a "start transmission" character (also called "XON")

Try using the stop/start characters: While scrolling through the CompuServe index, press **(CTRL) (S)** and CompuServe immediately stops transmission. Press **(CTRL) (Q)** and CompuServe starts transmission where it left off. (Whenever you "press" **(CTRL)** characters be sure to hold down **(CTRL)** while pressing the next character.)

You can use the start/stop characters only when: (1) the other computer follows the start/stop protocol, and (2) the Tandy 102 has its start/stop parameter enabled.

Using TELCOM's Function Keys

TELCOM has 2 modes: "interactive" and "terminal." Since you are connected to another computer, you are now in TELCOM's terminal mode. The terminal mode function keys are on the bottom of your screen:

Prev Down Up Full Bye

As always, you can turn this function-key display on and off with **(LABEL)**. You may want to turn it off to give you an extra line for displaying online information.

With the exception of the Upload key (described in the next chapter), all these keys are useful when retrieving information from a computer service.

Full/Half Duplex Key (F4)—

If you accidentally enter Half with most computer services, you see double of every character you type: Press **(F4)** to return to Full.

Previous Screen Key (F1)—

Use this key, as an alternative to the start/stop key, when information scrolls off the screen faster than you can read. Press **(F1)** to see the previous screen; then **(F1)** again to return to the current screen.

Echo Key (F5)—Use this key,

if you have a printer connected, to get a “hardcopy” of online information. Press **(F5)** and TELCOM immediately starts printing all online information. While this function is “on” you see “Echo” highlighted at the bottom. To turn off this function, press **(F5)** again.

Please note that the print function causes transmission to be much slower. The best way to get a hardcopy of online information is to “download” information into a text file, then print it.

Download Key (F2)—To save online information in a normal Tandy 102 text file, press **(F2)**; then enter a name with 6 or less characters. Example:

File to Download: **INDEX**
(ENTER)

While the download function is on, you see “Down” highlighted at the bottom of the screen. To turn off this function, press **(F2)** again or, when you run out of memory, TELCOM turns download off automatically.

After disconnecting from CompuServe you will see a new text file named INDEX.DO on the Main Menu—You can enter, edit, or print INDEX.DO just as you can with any text file.

Logging Off CompuServe

CompuServe computes your online time by the minute rather than the hour. If you logoff after using only 30 minutes of free time, for example, you can logon again for an additional 30 free minutes.

You can logoff CompuServe in either of the ways shown in Step 10 of the last chapter: (1) by pressing **CTRL D** or (2) by waiting until you see the “!” prompt, and then typing **BYE** **ENTER** or **OFF** **ENTER**.

After logging off, press **F8**, for Bye, and respond to TELCOM's Disconnect prompt by typing **Y** **ENTER**.

Subscribing to CompuServe

Each time you log on during your free hour, CompuServe asks if you want to read and agree to its service terms. By agreeing to these terms, you will be able to sign up, while online, for continued CompuServe service.

CompuServe then will ask for billing information. Be prepared to give either your: (1) Master charge number, (2) Visa charge number, or (3) bank address and checking account number.

After signing up, CompuServe bills you only for online time. The charge for online time is listed in Chapter 8.

How Electronic Mail Works

An electronic mail service typically lets you send text to the "mailbox" of any user on the system. Shortly after you send mail, the receiving user can then retrieve it. Some reasons for using electronic mail are:

- To send and receive mail quickly—In many cases, electronic mail costs less than that of a fast-delivery postal service.
- To transport information between computers—Electronic mail service can often be used by many kinds of computers; you can use this feature to transfer information to unlike computers.
- To temporarily store information—You can use electronic mail as a temporary storage area by storing information in your own mailbox.

This chapter uses CompuServe's EMAIL network as an example of an electronic mail service. To use EMAIL, you must be signed up for continued service with CompuServe.

Sending Mail

Note: Although your session with CompuServe should closely resemble the one described in this chapter, do not expect it to be identical. CompuServe often revises or improves its menus and prompts.

EMAIL expects you to send mail as follows: (1) First "compose" a message by typing it into EMAIL's workspace, and (2) then "send" the message to any CompuServe user's mailbox.

The charge for EMAIL is only the time you spend online with CompuServe. To save on online charges, we suggest you compose your message using TELCOM's Upload function: This function sends a pre-prepared text file to another computer just as if you were typing the text on the keyboard.

1. Create a pre-prepared text file to upload.

For this example, assume you want to send information to your home office about a prospective client. Enter the TEXT program and create a text file named CLIENT.DO containing this memo:

To: Home Office
From: Mary
Date: June 10, 1985
Re: Adis Beverage
Distribution

Adis wants this system automated:

- 200 sales orders per day
- 750-item customer list
- 50-item vendor list
- 300 invoices per month
- 90-item inventory

They need our proposal by July 1. George Jones, (213)888-1280, is our contact.

2. Enter EMAIL to compose and send a message.

Connect to CompuServe. Then:

- At the “!” prompt, type **GO EMA** (ENTER).
- At the Electronic Mail Menu, select the option to compose and send mail.
- At the Compose and Send Mail Menu, select the option that lets you “create” a new message using EDIT (also called FILGE).

EMAIL displays a reference number and waits for you to compose a message.

3. Upload the text file as your message.

For your message, use the text file you prepared earlier: Press the Tandy 102's Upload function key (F3). The Tandy 102 asks:

File to Upload?

Type the name of the text file you want to send, in this example type **CLIENT.DO** (ENTER). When the Tandy 102 asks “Width:”, simply press (ENTER). You then see your text file being entered as your EMAIL message, just as if you were typing it.

4. Send the EMAIL message to a CompuServe user.

After you finish uploading the Tandy 102 text file, you need to tell EMAIL that you have finished composing your message.

Type:

/EX (ENTER)

EMAIL then returns to the Compose and Send Menu. Select the option that lets you send a message (from your workspace).

EMAIL asks for a user ID as well as additional identifying information. In this example, send the message to your own mailbox by entering your own user ID number.

Receiving Mail

It takes CompuServe about 20-30 minutes to "deliver" the mail. After that, the next time you logon to CompuServe, you will be notified of your mail with this message:

You have mail

Anytime during your online session, you can retrieve your mail:

- At the "!" prompt, type **GO EMA** **(ENTER)**
- At the Electronic Mail Menu, select the option for read mail.

Before "reading" your mail, you may want to press TELCOM's download key (**F2**). This saves your mail in a Tandy 102 text file.

Using Other Electronic Mail Services

With CompuServe's EMAIL service, you have several limits: Your document can be no longer than 2,000 bytes (characters) and must be accessed within 30 days or else it is deleted.

Many other kinds of electronic mail services are available. Some let you send very large documents or deliver a "hard-copy" of your mail through the postal service. Other electronic mail services are listed in Chapter 8 of this manual.

How Public Bulletin Boards Work

Public bulletin boards are usually owned and operated by personal computer users as a service for other users. You can sometimes find telephone numbers of public bulletin board services in computer books and computer stores.

In addition, you can sometimes get telephone numbers of bulletin boards while online with one of the bulletin boards. For example, while online with the Comnet-80 Bulletin Board (817/767-5847), you can get numbers of many bulletin boards in the United States and Canada.

Although accessing a public bulletin board service is similar to the steps shown in Chapter 9, there are some differences:

- You do not need to make any prior arrangements with the service. Most bulletin boards are free and can be accessed by anyone that dials the number.
- You do not need to use a network to access the bulletin board. In most cases, you can simply call the bulletin board and immediately start using it.
- You may need to “experiment” with TELCOM parameters. Since you usually will not have made any prior arrangements with the service, you will have to try out different parameters.

Connecting to a Public Bulletin Board

Refer to Chapter 2 if you need help with these steps:

1. Set TELCOM's parameters—Try either of these most commonly-used settings:

M7E1E
M8N1E

2. Connect the Tandy 102 to the telephone.
3. Dial the number of the bulletin board.
4. Enter the TELCOM terminal mode.
5. Wait for the terminal function-key display.

At this point you should be connected to the bulletin board and can follow its prompts. Here again you need to experiment. Each bulletin board service uses its own prompts and menus.

If meaningless characters appear on your screen, you need to try a different TELCOM parameter setting. See Chapter 15 if neither of the most commonly-used settings work.

If no characters appear on your display, you may need to type some characters to get the bulletin board's attention. Try pressing **CTRL C**. (Hold down **CTRL** while pressing **C**.)

Disconnecting from a Bulletin Board

Many bulletin boards will prompt you to logoff before disconnecting. If so, follow the bulletin board's prompt.

To disconnect, press **FB** and answer TELCOM's disconnect prompt with **Y ENTER**.

Chapter 13/

Automatically Dialing and Logging On

Because dialing and logging on to computer services can become tedious, the Tandy 102 built-in modem comes with a feature that lets you do this with a single keystroke. To use this autodial/autologon feature you must have a direct-connect modem cable.

How to Use an Autodial/Autologon Sequence

In Chapter 5, you learned that you can store a telephone number in `ADRS.DO` and, by enclosing the number in colons, autodial the number from `TELCOM`.

Along with this telephone number, you can store an entire logon sequence. For example the following is the logon sequence for connecting and logging on to CompuServe using the CompuServe network:

```
CISCSN:5551212<^*07USERLYN^M?PSECRET^M>:
```

To use this sequence, enter the above line in the `ADRS.DO` file as one continuous line, substituting your own telephone number, user ID, and password. Then, whenever you want to connect to CompuServe, all you need to do is:

1. Set `TELCOM`'s parameters: Do this as shown in Chapter 9.
2. Connect to the telephone: Do this as shown in Chapter 9.
3. Find the autodial/autologon sequence: Press `TELCOM`'s find key (`F1`); then enter any characters in the record containing the sequence. In this example, type (`F1`) `CISCSN` (`ENTER`).
4. Call the autodial/autologon sequence: Press `TELCOM`'s call key (`F2`).

When `TELCOM` "calls" the autodial/autologon sequence, it automatically dials the number, establishes a terminal connection, and logs on—You never even need to pick up the telephone.

Commonly-Used Autodial/Autologon Sequences

The following are autodial/autologon sequences for CompuServe, Dow Jones, and The Source. To use one of these sequences, enter it into the `ADRS.DO` file as 1 continuous line. (Do not press (`ENTER`) until you have entered the entire sequence.) Substitute your own telephone number, user ID (if required), and password. Then automatically dial and logon to the service, as shown above.

When storing your telephone number, be sure to store all required digits. For example, a preliminary "1" or "9" may be required.

Also, if your ID or password includes any of the following special characters, you need to precede that character with the ! symbol:

```
= ^ ! ? < >
```

For example, if your password is `MAKE=EVEN`, you need to precede the = character with the ! symbol:

```
MAKE!=EVEN
```

Important Note: If you type any of the characters in a autodial/autolog sequence incorrectly, the sequence will not

work. For example, if the sequence requires a lower-case "t" and you type an upper-case "T", the sequence will not work.

CompuServe Autodial/Autologon

Using the CompuServe Network:

```
CISCOMPUSERVE:5551212<=^C7UUSERLYN^M?PSECRET^M>:
```

Using the Tymnet Network:

```
CISTYMNET:5551212<==A?p^PCPS01^M?UUSERLYN^M?PSECRET^M>:
```

Using the Telenet Network:

```
CISTELENET:5551212<=^M^M?TD1^M?BC 202202^M?UUSERLYN^M?PSECRET^M>:
```

Using the Datapac Network through CompuServe:

```
CISDATAPAC/COMPUSERVE:5551212<==.^M====29400138^M?HCIS^M?UUSERLYN^M?PSECRET^M>:
```

Using the Datapac Network through Tymnet:

```
CISDATAPAC/TYMNET:5551212<==.^M====P 1 3106, CPS^M?HCIS^M?UUSERLYN^M?PSECRET^M>:
```

Using the Datapac Network through Telenet:

```
CISDATAPAC/TELENET:5551212<==.^M====131106140227^M?HCIS^M?UUSERLYN^M?PSECRET^M>:
```

Dow Jones Autodial/Autologon

Using the Tymnet Network:

```
DOWTYMNET:5551212<==A?pDOW1;;?WDJNS^M?PSECRET^M>:
```

Using the Telenet Network:

```
DOWTELENET:5551212<=^M^M?TD1^M?BC 60942^M?WDJNS^M?PSECRET^M>:
```

Using the Datapac Network:

```
DOWDATAPAC:5551212<==...^M====13106,DOW1;;^M?WDJNS^M?PSECRET^M>:
```

The Source Autodial/Autologon

Using the Telenet Network:

```
SOURCETELENET:5551212<=^M^M?TD1^M?BC 30147^M?>^M?IID USERLYN SECRET^M>:
```

Using the Uninet Network:

```
SOURCE UNINET:5551212<==^M.^M?S15^M?>^M?IID USERLYN SECRET^M>:
```

How to Create an Autodial/Autologon Sequence

To create an autodial/autologon sequence, use this format:

:number<logon>:

number tells TELCOM what telephone number to autodial.

< > tells TELCOM to enter the terminal mode. By omitting the enclosed *logon* sequence, you can get TELCOM to simply enter the terminal mode without logging on. (Example: :8702461< >:)

logon tells TELCOM how to logon a computer service. It can consist of characters, which TELCOM will "send" to the service, and special symbols, which are listed below:

SYMBOL	TELLS TELCOM TO...
=	Pause for 2 seconds
^	Send the next character as a CTRL character.
?	Wait to receive the next character.
!	Send the next symbol as a character.

(The ! symbol is for when you need to send a special symbol as a character.)

Example of an autodial/autologon sequence:

CISCSM:870-2461<^C1U76338,44^M?PSECRET^M>:

The above autodial/autologon tells TELCOM to autodial the number 870-2461, enter the terminal mode, and logon to CompuServe as follows:

=	Pause for 2 seconds (This ensures that CompuServe will receive your first character.)
^C	Send CTRL C
?U	Wait to receive a line that contains a "U" character (the "U" in CompuServe's "User ID" prompt).
76338,44	Send 76338,44 (in this example, your user ID).
^M	Send ENTER (CTRL M sends the same character code as ENTER).
?P	Wait to receive a line with "P" (the "P" in CompuServe's "Password:" prompt).
SECRET	Send SECRET (in this example, your password)
^M	Send ENTER

At the end of the sequence, you can add additional requests. For example, if you want TELCOM to automatically request a quote from Tandy Corporation common stock after logging on to Dow Jones, you could add the following request to the end of the Dow Jones logon sequence:

```
?Q,TAN^M
```

The complete Dow Jones logon sequence (using the Tymnet network) would then look like this:

```
DOWTYMNET:5551212<=A?pDOW1;;?WDJNS^M?  
PSECRET^M?Q,TAN^M>:
```

Part 3/

Communicating with Private Computers

An excellent use of the Tandy 102 is to communicate with a “private” computer. For example, you could use the Tandy 102 to communicate with an office computer, a home computer, or a central timesharing computer.

In this part of the manual, you will learn which computers you can connect to the Tandy 102, how to make this connection, and how to get the two computers to communicate. If you are not interested in doing this, you can skip this part without feeling that you have missed any important information.

How TELCOM Communicates with Other Computers

TELCOM communicates with other computers by acting like a "terminal." As a terminal, TELCOM sends and receives information with another computer. You can use TELCOM to:

- Access the programs and data of a "host" computer such as a timesharing or home-office computer. (A host computer is a computer that can process commands that a terminal sends to it.)
- Exchange text files with another computer running a terminal program—such as a office or a home computer—or with a host computer.

TELCOM is able to communicate with many unlike computers by using certain communication conventions. These conventions govern how computers connect to each other, how they transmit and code data, and how they transfer files.

This chapter describes the conventions that TELCOM uses, which are widely-recognized by small computers and public-access computers. Any computer that is able to follow these conventions can communicate with TELCOM.

Connection

TELCOM lets you connect to another computer in 3 ways:

- Over the telephone, using the built-in modem.
- Over the telephone, using an optionally-purchased external modem.
- Directly, using an RS-232 cable.

For the connection to work, both computers must be able to transmit data at the same speed. This speed is measured in "bits per second" (bps) or "baud". In just about all cases, bps and baud are the same—A 300-bps modem is also a 300-baud modem.

- When using the built-in modem connection, TELCOM can transmit data at 1 rate only—300-baud. This is a common rate for telephone transmission.
- When using an external modem connection, TELCOM can transmit data at any rate the external modem is equipped to handle.
- When using the direct cable connection, TELCOM can transmit data at rates ranging from 75- to 19,200-baud.

Modem Connection. A modem lets you transmit data over the telephone by converting data to

modulated signals. When the modem at the other end of the line receives the signals, it "demodulates" them back to data. For this to work, both modems must understand each other's signals.

The built-in modem uses standard signals, called Bell-103 signals. These signals transmit data over the normal telephone line in 2 directions at the same time: The top part of the line carries the signals of the modem in the "originate" mode; the bottom part carries the signals of the modem in the "answer" mode.

Almost all 300-baud modems in America can use Bell-103 signals. In addition, many standard 1200-baud modems, such as Bell-212a modems, can transmit data at 300-baud using Bell-103 signals.

You may, however, want to connect to a computer that requires a different kind of line (such as a leased line) or a faster baud rate (such as 1200-baud).

If this is the case, you need to purchase an external modem to use with TELCOM. You can use any external modem that conforms to these 2 standards: (1) It must have an RS-232 interface and (2) It must be designed for use with asynchronous, rather than synchronous, transmission.

Some external modems come with intelligent features, such as autodial, autologon, and auto-answer features. TELCOM will not know how to use the intelligent features of an external modem.

RS-232 Connection. The RS-232-C interface connector was designed by the Electronic Industry Association (EIA) as a standard way to connect communications equipment (such as modems) to terminal equipment (such as computers).

Most external modems in America have the RS-232 interface and many international modems have a compatible interface called the V.24 interface. You can connect any modem that has either of these interfaces to the Tandy 102.

In addition to being a modem standard, the RS-232 has also become a standard way of directly connecting computers. Most American computers have the RS-232 connection—or at least have an option to add on this interface—and many international computers have the compatible V.24 interface. You can directly connect to computers with either of these interfaces.

The actual RS-232/V.24 interface standard consists of 25 signals, but like most computers and modems, the Tandy 102 uses only 7 of these signals:

Signal 2	Transmit data (T X D)
Signal 3	Receive data (R X D)
Signal 4	Request to send (RTS)
Signal 5	Clear to send (CTS)
Signal 6	Data set ready (DSR)
Signal 7	Common ground (GND)
Signal 20	Data terminal ready (DTR)

If the computer or modem you want to connect to the Tandy 102 uses more signals or less signals, this could cause transmission to hangup. You can usually correct this problem by having some wires on the RS-232 cable adjusted.

Echo

TELCOM follows a convention in which you can control whether it displays or does not display on the screen the characters you type or send from a file.

- If you want TELCOM to display your characters, you can turn TELCOM's echo on. (TELCOM calls this its "half-duplex" mode.)

- If you do not want TELCOM to display your characters, you can turn TELCOM's echo off. (TELCOM calls this its "full-duplex" mode.)

The reason for turning TELCOM's echo off is because of the way many host computers such as CompuServe use 2-way transmission: To let you know whether they received your characters correctly, these computers send you back an "echo" of each of your characters.

When communicating with a host computer such as CompuServe that echos your characters, you will want to turn TELCOM's echo off. Otherwise you will see each of your characters displayed twice—once by TELCOM and once by the host computer.

When communicating with a computer that does not echo your characters, you will want to turn TELCOM's echo on. Otherwise, you will not see any of your characters displayed.

Note: Unlike their names imply, TELCOM's full- and half-duplex modes control only whether TELCOM's echo is on or off. These modes have nothing to do with whether TELCOM uses 2- or 1-way telephone signals. Telephone signals are produced by your modem; the built-in modem always produces 2-way signals, regardless of what "duplex" mode TELCOM is using.

Transmission

TELCOM transmits data as a series of "bits" (0's and 1's) using an "asynchronous" transmission—the standard transmission for micro- and minicomputers. With this transmission, computers use a certain word length, parity, and stop bit setting to tell where each character begins and ends, and to check for certain transmission errors.

You do not need to understand the meaning of these asynchronous parameters as long as yours match the other computer's. If interested, though, here is a brief explanation:

- **Word Length**—tells how many bits are in each character.
- **Parity**—tells whether to include 1 extra bit with each character to check for some transmission errors.
- **Stop Bit**—tells how many bits are at the end of each character.

Large mainframe computers normally use synchronous, rather than an asynchronous transmission. With synchronous transmission, computers transmit data in carefully-timed batches using a protocol such as BSC or SDLC.

The only way you can get the Tandy 102 to communicate using synchronous transmission is (1) by purchasing a device called a protocol converter or (2) by using a service for protocol conversion such as the services offered by Tymnet and Telenet.

Codes

Computers transmit data as codes. When computers disagree on the meaning of codes, strange characters will appear on your screen. TELCOM uses widely-recognized standards for 2 kinds of codes—ASCII codes and sequence codes.

ASCII Codes. ASCII codes were developed by the American National Standards Institute (ANSI) as a standard way to represent text (such as letters and numbers) and common "control" functions (such as a carriage return or a tab). ASCII codes consist of 128 codes (Codes 0-127).

Almost all computers in North American, except for a few mainframes, can use ASCII codes. In addition, ASCII codes are only a slight national variation from an international standard for text codes, called International Alphabet 5.

Sequence Codes. In addition to ASCII codes, host computers sometimes use "sequence codes" to control a terminal in special ways. For example, a host computer's accounting program may send you an escape code (Code 27) followed by an "A" (Code 65) to center a line on your display.

Standards for sequence codes differ among terminals. TELCOM recognizes the sequence codes of the "VT-52 terminal." Other kinds of sequence codes will cause unpredictable results—usually strange characters on your display.

Other Kinds of Codes. In addition to ASCII codes and sequence codes, computers sometimes use an additional 128 codes (Codes 128-255) for special characters or control functions.

TELCOM uses Codes 128-255 for graphic, foreign, and special characters that are unique to the Tandy 102 and Model 100 computers—If another computer uses Codes 128-255 with TELCOM, these codes will cause strange characters to appear on your display.

File Transfer

TELCOM, like many other computers, can transfer text files (also referred to as "ASCII files," and "data files"). Some computers have options for transferring other kinds of files, such as "binary" files. TELCOM *cannot* transfer binary files—It can transfer text files only.

TELCOM lets you transfer text files in the following way: You can send any text file to another computer. TELCOM sends the text to the other computer just as if you were typing it on the keyboard. By the same token, you can store any text file being transmitted from the other computer in a Tandy 102 text file.

Some computers have options for using special error-checking methods when transferring files:

- **TELCOM can follow the "stop/start protocol" (also called "XON/XOFF handshaking protocol").** This protocol lets a computer tell TELCOM to stop and restart transmission—a function required by some computers when transferring files. To use



Chapter 15/

Setting Communication Parameters

This chapter gives background information on the communication parameters you can use when communicating with another computer.

Checking the Settings

Before communicating with another computer, you need to check TELCOM's communication parameters (Figure 15.1) and make sure that they are set correctly.

You can check these parameters when you first enter TELCOM and anytime before entering TELCOM's terminal mode by pressing (F3) (ENTER).

To change the parameter settings:

1. Press (F3) and you see the "Stat" prompt.
2. Enter the new parameter settings, for example **M7E1E** (ENTER). (You do not need to include the last parameter—the dial type—unless you want to change it.)

3. Check the newly-set parameters by pressing (F3) (ENTER).

What the Settings Mean

Some parameters settings—such as the connector—are extremely important. If set incorrectly, no transmission will take place. Other settings—such as the dial type—are less important. The following describes TELCOM's parameter settings in order of importance.

Connector (**M7E1E, 10 pps**).

Make sure this setting is correct. Otherwise, no transmission will take place.

Connector:

- M—PHONE (built-in modem)
- 1—RS-232, 75 baud
- 2—RS-232, 110 baud

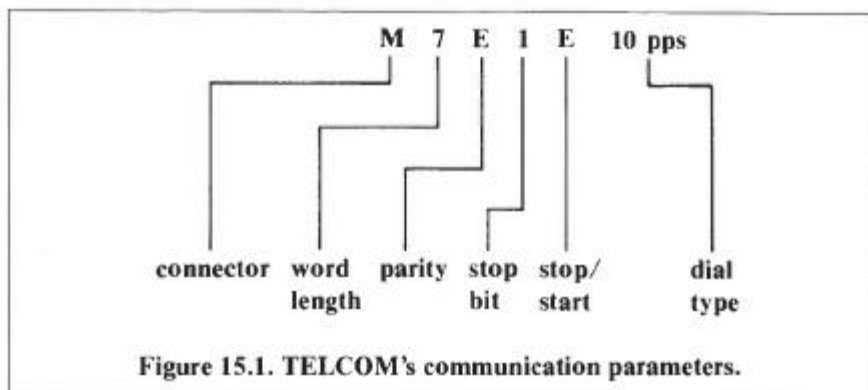

Figure 15.1. TELCOM's communication parameters.

- 3—RS-232, 300 baud
- 4—RS-232, 600 baud
- 5—RS-232, 1200 baud
- 6—RS-232, 2400 baud
- 7—RS-232, 4800 baud
- 8—RS-232, 9600 baud
- 9—RS-232, 19200 baud

This parameter tells TELCOM which connector to use: the built-in modem's PHONE connector or the RS-232 connector. It also tells TELCOM, if using the RS-232, what baud rate to use. (The built-in modem always uses 300 baud.)

(Remember that if you have an optional external modem, it connects to the RS-232—not the PHONE.)

Word Length, Parity, Stop Bit (*M7E1E, 10 pps*). Make sure these settings agree with the other computer. Otherwise, many of the characters transmitted will be meaningless.

- Word Length: 6—6 bits
- 7—7 bits
- 8—8 bits
- Parity: 1—ignore parity
- O—odd parity
- E—even parity
- N—no parity
- Stop bit: 1—1 stop bit
- 2—2 stop bits

It really does not matter what word length, parity, and stop bit values you use, as long as they agree with the other computer. (Exception: Do not use a word length of 6 unless you have a specific reason to do this.) If in doubt of what parameters the other computer is using, try the 2 most common settings: 7E1 and 8N1.

Stop/Start Protocol
(M7E1E, 10 pps)
(Also called XON/XOFF Handshaking Protocol)

Reset this only if you need to change start/stop control:

- Start/ Stop: E—Enable start/stop characters
- D—Disable start/stop characters

If the other computer continually stops transmission for no reason, set this parameter to "disable." If the other computer requires you to use the start/stop protocol, set this parameter to "enable."

By enabling the start/stop protocol, you can use the start/stop characters while communicating with any computer that also recognizes this protocol:

- To stop transmission: Press **CTRL S** (the stop character)
- To restart transmission: Press **CTRL Q** (the start character)

When communicating with a computer that does not recognize this protocol, we suggest you disable the stop/start characters; otherwise, the other computer may unintentionally send you stop characters and lock up transmission.

Dial Type (M7E1E, 10 pps).
Reset this only if you want to change TELCOM's autodialing method.

Dial Type: 10 pps—slow
pulse dialing
20 pps—fast
pulse dialing

Chapter 16/

Establishing a Connection—Using the Built-in Modem

This chapter shows how to establish a terminal connection with another computer using the Tandy 102 built-in modem. After establishing a connection, go to Chapter 19 to learn how to use TELCOM in its terminal mode.

Requirements

As stated in Chapter 14, the Tandy 102 built-in modem lets you connect over a normal telephone line to any other computer that has a compatible modem.

To use the built-in modem, you need to purchase one of the following so that you can connect the Tandy 102 PHONE connector (on the rear of the Tandy 102) to a telephone:

- The direct-connect modem cable (Cat. No. 26-1410)—This is the most reliable since it connects the built-in modem directly to the telephone wire.
or
- An acoustic coupler (Cat. No. 26-3805)—Use this when you cannot directly connect to a telephone (for example, when using a pay phone).

Establishing a Connection

Before starting, find out the following information about the other computer:

- Which mode it will use: originate or answer. (Host computers and information networks normally use "answer." Computers running terminal programs normally use "originate.")
- Which word length, parity, and stop bit settings it will use.

You should also make sure that the other computer will be communicating at a speed of 300 baud.

1. Set your communication parameters.

Enter TELCOM and make sure the important communication parameters are set correctly:

- The **connector** should be **M**.
- The **word length, parity, and stop bit** should **match** the other computer.

Example:

M7E1E,10 pps

This sets the connector to "M", the word length to "7", the parity to "even", and the stop bit to "1".

2. Connect the built-in modem to the telephone.

Tandy 102 Modem Cable: Connect the cable in either of the ways shown in Chapter 5 of this manual. Be sure to and set the ACP/DIR switch (on the left of the Tandy 102) to DIR.

Acoustic Coupler: Connect the coupler to the Tandy 102 PHONE jack (on the rear of the Tandy 102) and set the ACP/DIR switch (on the left of the Tandy 102) to ACP.

The remaining steps depend on whether you are going to use the "originate" or "answer" mode. It does not matter which mode you use, but it must be opposite from the mode that the other computer is using.

Use these steps if you are using the originate mode.

3. Set to "originate."

Set the ORIG/ANS switch (on the left of the Tandy 102) to ORIG.

4. Call the other computer.

By convention, you as the originator place the call, although TELCOM does not really care who does this.

5. Wait for a high-pitched tone.

When ready to communicate, the person at the other computer needs to do whatever procedures are necessary to enter the terminal mode—Once the other computer is in this mode, you will hear a high-pitched tone.

Note: Some computers will automatically answer—With these computers, you will immediately hear a high-pitched tone.

6. Press **F4** to enter the terminal mode.

If you are using an acoustic coupler, place the receiver in the coupler.



7. Wait for the terminal function-key display.

A few seconds after you enter the terminal mode, you should see the terminal function key display:

Prev Down Up Full Bye

This lets you know you have established a terminal connection with the other computer. You can test this by typing. Each character you type, TELCOM sends to the other computer; each character you receive from the other computer, TELCOM displays on your screen.

If you are connected to a host computer, you may need to send a special character so that the host will know you are online. For example, some hosts require that you send **CTRL C**—To do this press and hold down **CTRL**; then press **C** at the same time.

Use these steps if you are using the answer mode:

3. Set to "answer."

Set the ORIG/ANS switch (on the left of the Tandy 102) to ANS.

4. Have the other computer call you.

By convention, the other computer as the originator places the call, although TELCOM does not really care who does this.

5. Press **F4 to enter the terminal mode.**

Since you are in the answer mode, pressing **F4** causes you to produce a high-pitched tone; this is a signal to the other computer that you have entered the terminal mode.

If you have an acoustic coupler, place the receiver in the coupler:



6. Wait for the other computer to enter the terminal mode.

The person at the other computer should do whatever procedures are necessary to enter the terminal mode.

Note: Some computers will dial your number, wait for your high-pitched tone, and then enter the terminal mode—all automatically.

7. Wait for the function-key display.

A few seconds after the other computer enters the terminal mode, you should see the terminal function-key display:

Prev Down Up Full Bye

This lets you know you have established a terminal connection with the other computer. You can test this by typing. Each character you type, TELCOM sends to the other computer; each character you receive from the other computer, TELCOM displays on your screen.

If You Cannot Establish a Connection

If you cannot transmit any characters (even meaningless characters) with the other computer, go through all the steps again, checking each of the following:

- *The connectors:* If using the modem cable, make sure the beige wire goes to the wall line, the silver wire to the phone line, and the plug to the Tandy 102 PHONE jack. If using the acoustic coupler, make sure it is plugged into the Tandy 102 PHONE jack and that you insert the speaker and the receiver in the correct coupler "cups."
- *The ACP/DIR setting:* This should be ACP for the acoustic coupler and DIR for the direct modem cable.
- *The ORIG/ANS setting:* This should be opposite from the mode being used by the other computer.
- *The other computer's transmission signals:* These should be 300-baud, Bell-103 signals.
- *The connection parameter:* This should be "M".
- *The sequence you use to establish the connection:* The steps are different depending on whether you are set to originate or answer.

Requirements

As stated in Chapter 14, you can use a direct cable to connect to any other computer that has a compatible RS-232/V.24 interface. You also need to place the 2 computers 50 feet or closer to each other.

To connect the two computers, you need to purchase the following:

- A standard 25-pin RS-232 cable (such as Cat. No. 26-1408).
- A standard RS-232 null modem adapter (such as Cat. No. 26-1496).

Depending on your other computer, you may also need to purchase:

- An RS-232 male/female adapter
- An RS-232 cable extender

Connecting the Cable

1. Connect one end of the RS-232 cable to the Tandy 102 and the other end of the RS-232 cable to the null modem adapter.
2. Try connecting the null modem adapter to the other computer's RS-232 connector. (If the other computer's RS-232 has pins rather than holes, you need to use the male/female adapter.)

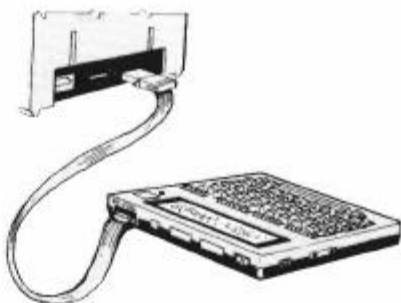

3. If this connection is not secure, use the RS-232 cable extender:

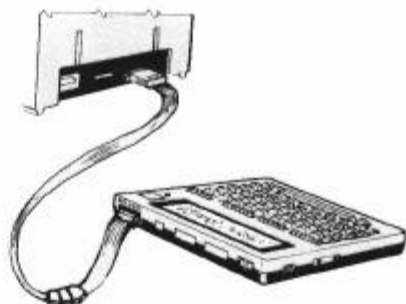

Establishing a Connection

Before starting, Find out this information about the other computer:

- Which baud rate it can use.
- Which word length, parity, and stop bit it can use.

Although TELCOM can use baud rates up to 19200, we suggest that you start by using a relatively low baud rate such as 1200 baud. Then, after seeing that the connection works, try higher baud rates. (With some computers, the higher baud rates will not work.)

1. Set TELCOM's important communication parameters:

- The **connector** should be set to an RS-232 baud rate—This baud rate should **match the other computer**.
- The **word length, parity, and stop bit** should **match** the other computer.

Example:

57EIE, 10 pps

This sets the connector to "5" (an RS-232 baud rate of 1200), the word length to "7", the parity to "even", and the stop bit to "1".

2. With both computers, enter the terminal mode.

To enter the Tandy 102's terminal mode, press (F4)—This causes the terminal-function key display to appear as shown below; however, you will not establish a connection until the other computer also enters its terminal mode.

Prev Down Up Full Bye

(It does not matter which computer enters the terminal mode first.)

3. Test the terminal connection.

After both computers enter the terminal mode, test that you have established a connection by typing characters. Each character you type should be sent to the other computer; each character the other computer sends should appear on your display. If you have established a connection, go to Chapter 19.

If You Cannot Establish a Terminal Connection

If you cannot transmit any characters (even meaningless characters), you may need to have the wires on the RS-232 cable adjusted. Before you decide you need to do this, though, make sure you have done all the steps correctly.

Press (FB) to exit the terminal mode and respond to TELCOM's "Disconnect" prompt with (Y) (ENTER). Then try the steps again, checking each of the following:

- **The connectors:** The connection must be correct and all connectors securely fastened.
- **The RS-232 baud rate:** This should match the other computer.
- **The terminal mode:** Both computers must enter the terminal mode.

Adjusting the RS-232

The RS-232 comes in 2 complementary versions—DTE and DCE. These 2 versions are designed to be connected to each other. The DTE version, for example, uses Signal 2 to *transmit* data; the DCE uses Signal 2 to *receive* data.

The Tandy 102, like most computers and terminals, uses the DTE version; the complementary DCE version is used by most modems. In other words, the Tandy 102 is actually designed to be connected to a modem—This is why, to connect the Tandy 102 to most other computers, you need a null-modem adapter.

The null-modem adapter crosses the wires in such a way that both computers' DTE's "think" they are connected to DCE's, as shown in Figure 17.1. This works fine when connecting to most other computers. There are, however, some exceptions:

Some computers use a DCE, rather than a DTE version of the RS-232: If this is the case, you should not use the null-modem adapter.

Some computers require different signals from the signals that the Tandy 102 requires: If this is the case, you need to have a technician cross the wires in the RS-232 cable in such a way that satisfies the signal requirements of both computers.

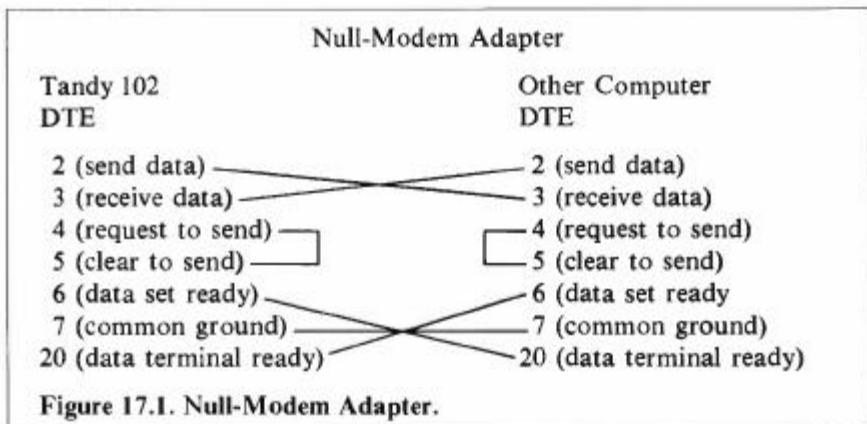

Requirements

You can purchase any external modem to use with TELCOM that meets the requirements listed in Chapter 14. To connect the modem to the Tandy 102, you will need to purchase an RS-232 cable.

Establishing a Connection

Before starting, find out the following information about the other computer:

- Which mode it will use: originate or answer. (This question is only applicable for external modems that use the originate/answer modes.)
- Which baud rate it will use.
- Which word length, parity, and stop bit settings it will use.

1. Connect the external modem.

Refer to the external modem's manual on how to connect the modem. (You will need to connect the modem to the Tandy 102's RS-232 connector, which is on the rear of the Tandy 102.)

2. Set TELCOM's communication parameters.

Enter TELCOM and make sure the important communication parameters are set correctly.

- The connector should be set to an RS-232 baud rate that matches both (1) the external modem and (2) the other computer.
- The word length, parity, and stop bit parameters should match the other computer.

Example:

57EIE, 10 pps

This sets the connector to "5" (an RS-232 baud rate of 1200), the word length to "7", the parity to "even", and the stop bit to "1".

3. Connect to the other computer.

Refer to the external modem's manual for these instructions:

- (a) How to make any required settings, such as the originate/answer setting. (The Tandy 102's originate/answer switch applies only to the built-in modem—*not* to an external modem.)
- (b) How to connect to the other computer over the telephone,
- (c) Which sequence the 2 computers should use to enter the terminal mode.

Then, using these instructions, connect to the other computer and enter TELCOM's terminal mode by pressing (F4). This causes TELCOM's terminal-function key to appear as shown below; however, you will not have established a connection with the other computer until both computers enter the terminal mode.

Prev Down Up Full Bye

5. Test the terminal connection.

After both computers enter the terminal mode, test that you have established a connection by typing characters. Each character you type should be sent to the other computer; each character the other computer sends should appear on your display.

If You Cannot Establish a Connection

If you cannot transmit any characters (even meaningless characters) with the other computer, go through all the steps again, checking each of the following.

- *TELCOM's connection parameter:* This should be an RS-232 baud rate that matches the external modem.

- *The other computer's baud rate and telephone signals:* This should be the same as the baud rate and signals used by TELCOM and the external modem.
- *The external modem's connection:* Refer to the modem's manual.
- *The external modem's settings (such as originate/answer):* Refer to the modem's manual.
- *The sequence you use to establish a connection:* Refer to the modem's manual.

If you still cannot transmit any characters, it may be because of an incompatible RS-232 connection.

Adjusting the RS-232 Cable

As stated in Chapter 14, the Tandy 102 uses 7 of the RS-232's 25 signals. If the external modem uses less or more signals, this could cause transmission to hang-up. You will need to have a technician cross the wires of the RS-232 cable in such a way that satisfies the requirements of both TELCOM and the external modem.

Communicating with Another Computer

After establishing a connection with another computer, you are in TELCOM's terminal mode. Whenever you type a character, TELCOM sends that character to the other computer as a code. Whenever the other computer sends you a code, TELCOM displays that code on your screen as a character.

For example, if you type the letter "A", TELCOM sends Code 65 to the other computer. If the other computer sends you Code 65, TELCOM displays the letter "A" on your screen. Reference F lists the codes that TELCOM uses for each character.

Using Control Characters

While in TELCOM's terminal mode, you may find it useful to use the following control characters:

- CTRL H** to backspace
- CTRL S** to temporarily stop transmission
- CTRL Q** to restart transmission

To use a control character, press **CTRL** and while holding down **CTRL**, press the next character. For example, to backspace, press **CTRL** and while holding down **CTRL**, press **H**.

Computers sometimes disagree on the meaning of the codes for control characters. For example, the other computer may not agree that the code for **CTRL H** means that it should backspace. If this is the case, you cannot use **CTRL H** to backspace while communicating with that computer.

Using TELCOM's Function Keys

While in TELCOM's terminal mode, you may find it useful to use the following function keys.

Prev (F1). Although you can see only 8 lines on your display, TELCOM keeps 16-lines in its memory at all times. To see the previous screen, press **F1**. To return to the current screen, press **F1** again.

Full/Half (F4). If you cannot see the characters you type, press **F4** to go to turn on the local echo ("half duplex"). If you are seeing double of the characters you type, press **F4** to turn the echo off ("full duplex").

Echo (F5). If you have a printer connected, press **F5** to turn the print function on. All information being transmitted will be printed on your printer. To turn off this function, press **F5** again.

Up (F3) and Down (F2).

These two keys let you exchange files with the other computer. Exchanging files is described below.

Bye (F6). This key lets you disconnect from the other computer and exit TELCOM's terminal mode.

Transferring Files

As stated in Chapter 7, TELCOM can send and receive text files only (files with the .DO extension). The latter part of this chapter shows how to convert a BASIC file to the text file format.

Sending a Text File:

1. Other Computer: Prepare for receiving the file.

Select the option that lets the other computer receive a text file. ("Receive" might also be referred to as "capture" or "download." "Text file" might also be referred to as a "data file" or an "ASCII file.")

When selecting this option, please note that you cannot use any special transfer method with TELCOM other than the stop/start (also called XON/XOFF) method. (To use the stop/start method, you must have TELCOM's start/stop communication parameter set to "enable.")

2. Tandy 102: Send the file.

Press TELCOM's Upload key (F3) and TELCOM asks for a filename. Enter the name of any file that has the .DO extension. Example:

File to Upload:
SAMPLE.DO (ENTER)

TELCOM asks "Width:". You can press (ENTER) or you can enter a line width from 1-132 characters. For this example, press (ENTER).

By pressing (ENTER), TELCOM sends the file to the other computer in the same way the file is stored. This is the best way to send a file that will be loaded into another computer's word processing program.

By entering a line width, TELCOM formats the file by sending it to the other computer with carriage returns at the end of each line. You may want your file formatted attractively if you are sending it to an electronic mail service.

Receiving a Text File:

1. Tandy 102: Prepare for receiving the file.

Press TELCOM's Download key (F2) and TELCOM asks for a filename. Enter the name you want to use for storing the file.

Example:

File to Download: **SAMPLE**
(ENTER)

TELCOM highlights the word "Down" to let you know that this function is "on." Any information being transmitted will be stored in SAMPLE.DO.

2. Other Computer: Send the text file.

Select the option that lets the other computer send a text file. ("Send" might also be referred to as "upload." "Text file" might also be referred to as a "data file" or an "ASCII file.")

When selecting this option, please note that you cannot use any special transfer method with TELCOM other than the stop/start (also called XON/XOFF) method. (To use the stop/start method, you must have TELCOM's start/stop communication parameter set to "enable.")

3. Tandy 102: Turn the download function off.

After receiving the entire file, press (F2) again. This turns the download function off; the word "Down" is no longer highlighted.

Converting BASIC Files for Transfer

You can transfer BASIC programs with another computer by converting them to text files using BASIC's "ASCII" option.

To send a BASIC program:

1. From the Main Menu, enter BASIC. Press (F2), for Load, and enter the name of the BASIC program you want to send. For example, type **HELLO** (ENTER).
2. Press (F3), for Save. Then enter a filename using the format: *filename*, A. For example, type **HELLO**, A (ENTER). This causes BASIC to save the BASIC program as an ASCII file.
3. Return to the Main Menu. The ASCII file has a .DO extension which indicates that it is in the text file format.
4. Enter TELCOM and send the ASCII file to the other computer as instructed above in "Sending a Text File."
5. When the other computer receives ASCII file, it will need to load the file into its own version of BASIC using the ASCII option of its BASIC load command.

To receive a BASIC program:

1. Have the other computer save the BASIC program as an ASCII file. Then have the other computer send the ASCII file to you. When you receive the ASCII file, it will have a .DO extension.

2. Enter BASIC. Then type the MERGE command in this format: MERGE "*filename*" **(ENTER)**. Be sure to include the .DO extension. For example, type MERGE "**HELLO.DO**" **(ENTER)**. This causes BASIC to load the ASCII file.

3. Press **(F3)**, for Save, and enter a filename. For example, type **HELLO (ENTER)**. This causes BASIC to save the file as a BASIC program.

References

- A. Help
- B. TEXT Special Features
- C. Memory Required by TEXT Paste Buffer
- D. BASIC Programs
- E. Tandy 102 Technical Information
- F. TELCOM Codes

Reference A/ Help

This reference helps with problems you may encounter while going through this manual. For additional help, see the Tandy 102 Applications and BASIC Reference Guide.

General

Red battery light on. When the light first comes on, you have 20 minutes of battery power left. Immediately turn the power off, and insert new batteries or use the AC power cord.

Screen and keyboard freezes. This could be caused by several factors: (1) An operation may be in progress. Press (SHIFT) and then (BREAK) at the same time. Try this several times. (2) The Tandy 102 may be hung up. At last resort, press Reset, the small button on the rear of the Tandy 102 next to the RS232C connector. Try this several times.

Cannot return to Main Menu. Press one of the following keys: (F8), the spacebar, or (SHIFT) (BREAK) (at the same time).

No files are on the Main Menu. Check the Memory Switch on the bottom of the Tandy 102. If it is off, all the contents in RAM have been permanently erased.

Screen blank. Use the DISP dial on the right side of the Tandy 102 to adjust your display. If this does not help, turn the power switch off and back on again. Then check for dead batteries or an improperly connected AC power cord.

Image not clear. Use the DISP dial (located on the right side of the Tandy 102) to adjust the screen to your field of vision.

Characters printing as numbers. Depress the NUM key (at the bottom of the keyboard) and the right keys print as characters, rather than numbers on a numeric keypad.

Characters printing as all caps only. Depress **CAPS LOCK** to get in the upper- and lowercase mode.

Tandy 102 is off, but the Power Switch is on. The Tandy 102 has turned itself off automatically. Press the Power Switch off and back on again.

Tandy 102 "beeps" for no apparent reason. This might be because you are at the Main Menu and have inadvertently pressed a number of keys. Press **ENTER** to clear the "Select:" line, which is at the bottom of the screen.

TEXT, SCHEDL, and ADDRSS

Insertion is slow. This happens when you are inserting text at the beginning of a long scrolling string of text. To shorten the text string, insert a carriage return by pressing **ENTER**. (You can delete the carriage return later.)

Memory full error. Select a smaller block of text. See "Reference C, Memory Required by the TEXT Paste Buffer."

BASIC

TM Error. Type the command again exactly as shown in the manual. You have probably omitted quotation marks or a dollar sign.

SN Error. Type the command again. You have made a typographical error.

FF Error. Type the command again using the complete filename, including the extension. Be sure you spell it as shown on the Main Menu.

Program running continuously. Press (SHIFT) (BREAK) to stop program execution.

Program ill-formed. The BASIC program contains lines without line numbers in the beginning. Go back to TEXT and be sure each line in the BASIC program begins with a line number and ends with an (ENTER) character.

TELCOM

Communication problems are caused by many factors: a bad telephone line, a defective cable, an improper connection of a cable, a mismatch of communication parameters, a switch set incorrectly, or a disagreement between TELCOM and the other computer on codes.

This section helps isolate what is causing a certain problem and suggests ways to correct the problem. It contains information on 4 kinds of problems:

“Problems with the Connection,” “Problems with the Characters You Receive,”

“Problems with the Characters You Type,” and “Problems with Using the Upload and Download Keys.” For a better understanding of what causes communication problems, read Chapter 14, “Which Computers Can Communicate with TELCOM.”

Problems with the Connection

Cannot establish a connection.

If TELCOM does not show its terminal function-key display (Prev, Down, Up, Full, Echo, Bye), you have not established a connection. See Chapter 9 if you are attempting to connect to a public computer service. See Chapter 16, 17, or 18 if you are attempting to connect to a private computer.

Communication hangs-up. This may be because TELCOM's start/stop protocol is enabled and the other computer does not recognize the same protocol. Disconnect and set TELCOM's start/stop parameter to "D", as described in Chapter 15.

The message "Lost Carrier" appears. The other computer is no longer on the telephone line. Disconnect and try the connection again.

Problems with Characters You Receive

You receive many strange characters. This could be caused by either of these factors:

- A mismatch of word length, parity, stop bit. Disconnect and reset TELCOM's parameters to match the other computer, as described in Chapter 15.
- A mismatch of baud rates. If using the built-in modem, you can use only 1 baud rate—300 baud. The other computer must also use 300 baud. If using the RS-232, you need to disconnect and set the RS-232 baud rate to match the baud rate used by the other computer, as described in Chapter 15.

You receive occasional strange characters. This could be caused either of these factors:

- A bad telephone connection. Disconnect and try the connection again.
- A disagreement between TELCOM and the other computer on the meaning of control, extension, or sequence codes. Find out the other computer has a way to avoid sending you the codes that are causing the problems. (See Chapter 14 and Reference F for information on TELCOM's codes.)

The lines you receive are printing on top of each other. This is caused by a disagreement between you and the other computer on whether to send line feeds after carriage returns. Find out if the other computer can adjust its carriage return/line feed codes.

The lines you receive are double spacing. This is caused by a disagreement between you and the other computer on whether to send line feeds after carriage returns. Find out if the other computer can adjust its carriage return/line feed codes.

The lines you receive are scrolling off the screen faster than you can read them. Try either of the following:

- Press (F1) to see the previous screen. Press (F1) again to see the current screen.
- Press (CTRL) (S) to temporarily stop transmission; then (CTRL) (Q) to restart transmission. (This works only if the other computer recognizes the start/stop protocol and if the TELCOM's start/stop parameter is set to "E", as described in Chapter 15.)

Problems with Characters You Type

The characters you type appear in duplicate. Press (F4) to change from "Half" to "Full".

The characters you type are not displayed. Press (F4) to change from "Full" to "Half".

The characters you type appear differently on your display. The host computer is echoing back the characters it is receiving from you, and they are different from the characters you are typing. This could be caused by either of these factors:

- A bad telephone line. Disconnect and try the connection again.

- A mismatch of word length, parity, or stop bit parameters. Disconnect and reset these parameters, as described in Chapter 15.
- A mismatch of baud rates. If using the built-in modem, you can use only 1 baud rate—300 baud. The other computer must also use 300 baud. If using the RS-232, you need to set the RS-232 parameter to the baud rate that the other computer is using, as described in Chapter 15.

The stop/start characters you send do not work. This could be caused by these factors:

- TELCOM's stop/start protocol is not enabled. Disconnect and set TELCOM's start/stop protocol to "E", as described in Chapter 15.
- The other computer does not use the start/stop protocol. You cannot use the stop/start characters with this computer.
- The other computer and TELCOM use different start/stop characters. You cannot use the start/stop characters with this computer.

A control character does not work. This is because TELCOM and the other computer disagree on the meaning of the control code. (See Chapter 14 and Reference F for a description of TELCOM's codes.)

The lines you type are printing on top of themselves. TELCOM does not have a way of adjusting this.

Problems with the Upload and Download Keys

Upload function prints "No file" error after you type the file name. You can upload only text files (files with a .DO extension). See chapter 19 for information on how to convert BASIC files to text files.

Download function turns off.

The Tandy 102 has no more memory available for storing the file.

Reference B/ TEXT Special Features

This reference lists some additional special features that you can use with the TEXT program. The first section shows how to use special printer codes for functions such as underlining text. The second and third sections show how you can use special character and control keys. The fourth section shows how you can transmit TEXT files to another computer without ever exiting the TEXT program.

Printer Codes

Many printers recognize printer codes that cause them to print text in a special way. Examples are codes that cause a printer to print underlined or boldface characters.

The TEXT program lets you "embed" printer codes into a text file. Then, for the printer to recognize these embedded printer codes, you need to print the file a special way.

Embedding printer codes. To embed a printer code into a text file, you need to first press **CTRL (P)**, then press the keyboard character that generates the printer code that you want to use.

To find out which printer code you want to use, you need to refer to the manual that comes with your printer. To find out which keyboard character generates this code, you need to refer to Reference F in this manual.

For example, assume you want to embed printer codes into a text file that tell the printer to underline the word "only":

To use this feature, you can print text in only 1 way.

By referring to your printer's manual, you find out that your printer recognizes decimal Code 15 as a code to start underlining text and decimal Code 14 as a code to stop underlining text.

By referring to Reference F, you find out that you can generate Code 15 with the **CTRL O** keys and Code 14 with the **CTRL N** keys.

Using this information, you could embed the underlining codes into your text file by entering **CTRL P** followed by **CTRL O** before the word "only" and **CTRL P** followed by **CTRL N** after the word "only."

(Please note that whenever you enter a **CTRL** key, you need to hold down **CTRL** while pressing the next key. For example, to enter **CTRL P**, you need to hold down **CTRL** while pressing **P**.)

The following shows how the printer codes will look on your screen:

To use this special feature, you can print text in
^Oonly^N 1 way.

Printing the embedded codes:

To print a text file with embedded printer codes, you need to print the file in a special way. Instead of pressing **SHIFT PRINT**, as you normally would do, you need to press **F3**, for Save, and then type **LPT: ENTER**.

Because you must print the file using **F3 LPT: ENTER**, rather than **SHIFT PRINT**, you will not be able to use the "Width" feature; you will need to format your text by inserting carriage returns where you need them.

Note: If you print the file by pressing **SHIFT PRINT**, the printer will not recognize the codes as being printer codes. Instead, it will print the codes in the same way that they are displayed on your screen.

Special Character Keys

The TEXT program lets you use special character keys to display graphics and foreign characters on the screen. The special characters you can display are listed in Reference F of this manual.

To use a special character key, press **(GRPH)** or **(CODE)**, and, while holding down this key, press the next key. For example, press **(GRPH) (Q)** and TEXT displays a stick figure on the screen. Press **(CODE) (Q)** and TEXT displays an "a" with an umlaut.

Please note that although you can display these special characters on the screen, you cannot print them on the printer. This is because the special characters that the Tandy 102 uses are unique to the Model 100 and Tandy 102 computers—They are not recognized by printers or other computers.

Special Control Keys

The TEXT program lets you use the following control keys to do the same editing and cursor movement functions that were discussed in Chapters 2 and 3.

To use a control key, press **(CTRL)**, and while holding down **(CTRL)**, press the next key. For example, by pressing **(CTRL) (X)**, you can move the cursor down 1 line.

Control

Character: Operation:

- (CTRL) (A)** Same as **(SHIFT) (-)**
- (CTRL) (B)** Same as **(SHIFT) (I)**
- (CTRL) (C)** Same as **(SHIFT) (BREAK)**
- (CTRL) (D)** Same as **(-)**
- (CTRL) (E)** Same as **(I)**
- (CTRL) (F)** Same as **(SHIFT) (-)**
- (CTRL) (G)** Same as Save function key
- (CTRL) (H)** Same as **(BKSP)**
- (CTRL) (I)** Same as **(TAB)**
- (CTRL) (L)** Same as Select function key
- (CTRL) (M)** Same as **(ENTER)**
- (CTRL) (N)** Same as Find function key
- (CTRL) (O)** Same as Copy function key
- (CTRL) (Q)** Same as **(CTRL) (-)**
- (CTRL) (R)** Same as **(CTRL) (-)**
- (CTRL) (S)** Same as **(-)**
- (CTRL) (T)** Same as **(SHIFT) (I)**
- (CTRL) (U)** Same as Cut function key
- (CTRL) (V)** Same as Load function key
- (CTRL) (W)** Same as **(CTRL) (I)**
- (CTRL) (X)** Same as **(I)**
- (CTRL) (Y)** Same as **(SHIFT) (PRINT)**
- (CTRL) (Z)** Same as **(CTRL) (I)**

Transmitting Text Files to Other Computers

You can use the TEXT program's Save and Load functions to transmit text files to other computers. This will accomplish the same purpose as the TELCOM program's Upload and Download functions (discussed in Part 3); however, by using Save and Load, you never need to exit the text file.

To use this feature:

1. Connect to the other computer and prepare the other computer for receiving or sending a text file.
2. At the Tandy 102, do one of the following:

To send a file: Enter the text file you want to send and press Save (**F3**).

To receive a file: Create or enter a text file that you want to use for storing the incoming file and press Load (**F2**).

3. TEXT will then prompt you with "Save to:" or "Load from" Enter this transmission information:

If using the built-in modem connection: **MDM:wpbs**

If using the RS-232 connection: **COM:rwpbs**

For *r*, *w*, *p*, *b*, and *s*, enter the baud rate (RS-232 connection only), word length, parity, stop

bit, and start/stop enablement parameters that the other computer is using.

For example, assume you are connected to another computer with the RS-232 connection and the other computer is using 9600 baud, 8-bit word length, even parity, 1 stop bit, and start/stop enabled. In response to "Save to:" or "Load from" type **COM:88E1E** (**ENTER**).

As another example, assume you are connecting another computer with the built-in modem connection and the other computer is using 7-bit word length, ignored parity, 2 stop bits, and start/stop disabled. In response to "Save to:" or "Load from" type **MDM: 712D** (**ENTER**). (When using the built-in modem connection, the other computer must be transmitting at 300 baud.)

After entering the transmission information, TEXT will send a copy of your text file to the other computer or receive and store a text file from the other computer.

A Note to BASIC Programmers: You can use the same method to transmit a BASIC program to another computer. First, load the program into TEXT by typing **EDIT [ENTER]**. Then, transmit the program to the other computer as described above. The other computer will receive the program as an ASCII file and will need to load the file into its version of BASIC. (See pages 106 and 107.)

Reference C/ Memory Required by the TEXT Paste Buffer

This reference explains the memory that the TEXT program's paste buffer needs to use to cut and paste or copy and paste text.

Whenever you cut or copy text, TEXT puts a copy of that text in the paste buffer, and the text remains in the paste buffer until you replace it with something else. This requires additional memory—more than you might at first think is necessary.

For example, assume you want to **cut and paste** 5,000 bytes (characters) of text. To do this, you need an additional 5,000 bytes of memory for the paste buffer to use.

- When you “cut” the text, TEXT **moves** the 5,000 bytes from the text file to the paste buffer.
- When you “paste” the text, TEXT **puts an extra copy** of the 5,000 bytes into the text file.

As another example, assume you want to **copy and paste** 5,000 bytes of text. To do this, you need an additional 10,000 bytes of memory—5,000 bytes for the paste buffer to use and 5,000 bytes for the copy.

- When you “copy” the text, TEXT **puts an extra copy** of the 5,000 bytes into the paste buffer.
- When you “paste” the text, TEXT **puts an extra copy** of the 5,000 bytes into the text file.

If you do not have enough memory to cut and paste or copy and paste a large block of text, TEXT will give you a “memory full” error. An easy solution to this problem is to simply divide the large block into smaller blocks and then work with each block individually.

In Case of Problems: The following BASIC program is useful if you cut a large block of text and, when you attempt to paste it, encounter a Memory Full error. It lets you use cassette tape to retrieve the contents of the paste buffer:

```
10 OPEN "CAS:" FOR
   OUTPUT AS 1
20 LINE INPUT AS
30 PRINT #1, AS
40 GOTO20
```

To use this program, you need to exit TEXT and enter BASIC. Then, in BASIC: (1) Type the above program. (2) Connect your recorder and set it to Play and Record. (3) run the program and, immediately after running it, press the Paste key.

The contents of the paste buffer are sent to the display, as well as to the recorder. When all of the contents have been displayed, this indicates that everything has also been sent to the recorder. Press **(SHIFT) (BREAK)** and then type CLEAR to clear the paste buffer.

Exit BASIC and re-enter TEXT. Then in TEXT, press LOAD **(F2)** and type CAS: **(ENTER)** then set the recorder to play. This loads the contents of the paste buffer back into TEXT.

Reference D/ BASIC Programs

This reference provides some simple BASIC programs you might want to enter and save. When entering a BASIC program, you must type it exactly as shown. A misspelled word or misplaced parenthesis could cause the program not to run.

LOAN.BA

This program computes a full amortization table of a loan. You input: (1) the full amount of the loan (do not type a comma or a dollar sign), (2) the interest you pay, and (3) the total number of months to pay off the loan (for example, 20 years X 12 = 240 months).

```
10 CLS:INPUT "TYPE
LOAN AMOUNT";L
```

```
20 INPUT "ANNUAL IN-
EREST RATE IN PER-
CENT";R
30 INPUT "NUMBER OF
MONTHS TO PAY OFF
LOAN";M
40 R = R * .01/12
50 P = R * L/(1-(1+R)^(-
M))
60 I%=1:OA = L:CLS
70 PRINT "NUMBER IN-
TEREST PRINCIPAL NEW
BAL"
80 F1$ = "### ##,###.## ##,
###.## ##,###.##"
90 F2$ = "MONTHLY
PAYMENT = $##,###.##"
100 F3$ = "TOTAL IN-
TEREST PAID = $##,###.##"
110 X = X + 1
120 MC = R * L
130 PP = P-MC
140 NB = L-PP
150 TI = TI + MC
160 PRINT USING
F1$;I%,MC,PP,NB
170 IF X = 6 THEN
GOSUB 240
180 IF I% <> M THEN I%
= I% + 1: L = NB: GOTO
110
190 GOSUB 240
200 PRINT "ON $ " OA
"LOAN AT " R*1200 "% IN-
TEREST RATE FOR " I%
"MONTHS"
210 PRINT:PRINT USING
F2$;P
220 PRINT USING F3$;TI
230 END
240 INPUT "PRESS (ENTER)
TO CONTINUE";RS: X = 0:
CLS
250 RETURN
```

SORT.BA

This program sorts all the records in *ADRS.DO*; then stores the sorted list in *SORT.DO*.

Warning: If you already have a file named *SORT.DO*, running this program will delete all information in the file.

You can rename *SORT.DO* with the *NAME* command described in Chapter 2.

```
10 CLEAR 1000:DIM
   N$(100)
20 CLS:I=1
30 OPEN "ADRS.DO" FOR
   INPUT AS 1
40 IF EOF(1) THEN 80
50 LINE INPUT #1, N$(I)
60 I=I+1
70 GOTO 40
80 CLOSE #1
90 OPEN "SORT.DO" FOR
   OUTPUT AS 1
100 CLS
110 PRINT @ 137,
   "SORTING"
120 I = I-1
130 X=0
140 X=X+1
150 IF X > I THEN 230
160 IF N$(X) = "ZZ" THEN
   140
170 FOR Y = 1 TO I
180 IF N$(Y) < N$(X) THEN
   X=Y
190 NEXT Y
200 PRINT #1, N$(X)
210 N$(X) = "ZZ"
```

```
220 GOTO 130
230 CLOSE #1
240 PRINT @ 137,
   "FINISHED"
250 END
```

BAR.BA

This program lets you input 12 numbers, then displays a simple bar chart of the numbers. (When you have finished running the program, press **(SHIFT)** **(BREAK)**.)

```
10 CLEAR 1000:DIM D(12)
20 FOR I=1 TO 12
30 READ D(I)
40 IF D(I)>YH THEN
   YH=D(I)
50 NEXT I
60 YL=YH
70 FOR I=1 TO 12
80 IF D(I)<YL THEN
   YL=D(I)
90 NEXT I
100 CLS: M=1:XA=282
110 FOR I=1 TO 12
120 PRINT @ XA,M;
130 XA=XA+3:M=M+1
140 NEXT I
150 P=(YH-YL)/45:X1=16
160 FOR I=1 TO 12
170 Y1=(YH-D(I))/P
180 LINE
   (X1,Y1)-(X1+8,46),1,BF
190 X1=X1+18:Y1=0
200 NEXT I
210 GOTO 210
220 DATA
   36,36,32,33,32,29,31,30,
   31,44,53,60
```

Reference E/ Tandy 102 Technical Information

This reference contains information on how to change the Tandy 102 default power up conditions, how to restore it to its original memory condition, and also gives technical information on all the Tandy 102 device interfaces.

Auto Power-Off Settings

If inactive for 10 minutes, the Tandy 102 turns itself off. You can change this 10-minute time interval or completely cancel the power-off function.

To change the 10-minute time interval: Enter BASIC and type the POWER command using the format **POWER n**. *n* is a number from 10 to 255—The Tandy 102 will multiply *n* times 6 seconds. For example:

POWER 10 (ENTER)

The above command sets the time interval to 1 minute (10 X 6 seconds = 60 seconds):

To cancel the auto power-off function: Enter BASIC and type the following:

POWER CONT (ENTER)

Cold Restart

If you ever need to restore the Tandy 102 to its original memory condition, you can do so with a cold restart.

Warning: This will erase all files you have stored in memory.

To do a cold restart, press (CTRL) (PAUSE) while either pressing the Power Switch or pressing Reset.

Specifications

Power Source: AA Battery (x4)
(23-552) AC Adapter (DC 6V,
Center minus) (26-3804)

Temperature: Operating 55°F
(13°C) to 85°F (29°C) Storage
-40°F (-40°C) to 160°F
(71°C)

Humidity: Operating 20% to
85% RH (non-condensing)
Storage 10% to 95% RN
(non-condensing)

Micro Processor: 80C85 (8 bits
CPU) 2.4 MHz

RS-232-C Interface

RS-232C Interface		
Pin No.	Symbol	Description
1	GND	
2	TXD	Transmit Data
3	RXD	Receive Data
4	RTS	Request to send
5	CTS	Clear to send
6	DSR	Data set ready
7	GND	
8	N C	
9	N C	
10	N C	
11	N C	
12	N C	
13	N C	
14	N C	
15	N C	
16	N C	
17	N C	
18	N C	
19	N C	
20	DTR	Data terminal ready
21	N C	
22	N C	
23	N C	
24	N C	
25	N C	

Cassette Interface

Cassette Interface		
Pin No.	Symbol	Description
1	REM 1	Remote
2	GND	
3	REM 2	Remote
4	R x C	Receive data for CMT
5	T x C	Transmit data for CMT
6	GND	GND
7	N C	
8	N C	

Input level: Impedance 100 ohm
(800 mV - 5Vpp)

Output level: Impedance 3.3 Kohm
(650 mVpp)

REMote: 6V DC 0.5A max.

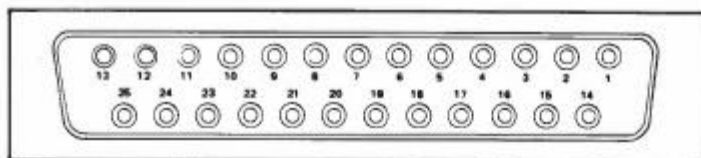
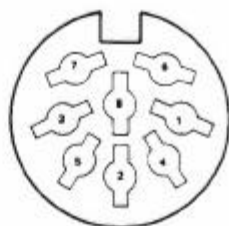

Parallel Printer Interface

Parallel Printer Interface (Centronics)		
Pin No.	Symbol	Description
1	STROBE	Strobe pulse from the Computer to printer.
2	GND	Ground
3	PD0	Bit 0 (lsb) of output data byte
4	GND	Ground
5	PD1	Bit 1 of output data byte
6	GND	Ground
7	PD2	Bit 2 of output data byte
8	GND	Ground
9	PD3	Bit 3 of output data byte
10	GND	Ground
11	PD4	Bit 4 of output data byte
12	GND	Ground
13	PD5	Bit 5 of output data byte

Parallel Printer Interface (Centronics)		
Pin No.	Symbol	Description
14	GND	Ground
15	PD6	Bit 6 of output data byte
16	GND	Ground
17	PD7	Bit 7 of output data byte
18	GND	Ground
19	N C	
20	GND	Ground
21	BUSY	Input to Computer from Printer
22	GND	Ground
23	N C	
24	GND	Ground
25	BUSY	Input to Computer from Printer, high indicates device selected.
26	N C	

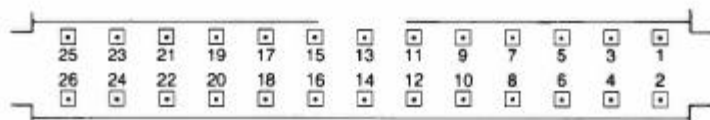

Modem Interface

Modem Interface		
Pin No.	Symbol	Description
1	TL	Conventional Telephone Unit
2	GND	Logic GND
3	R x MD	Direct Connection to Tel Line (RING)
4	R x MC	Acoustic Coupler Connection (MIC)
5	T x MC	Acoustic Coupler Connection (Speaker)
6	VDD	RD for answering telephone
7	T x MD	Direct Connection to Tel Line (TIP)
8	RP	Ringing Pulse

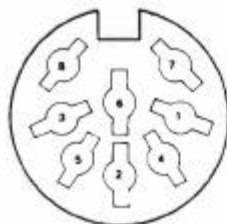

Bar Code Reader Interface

Bar Code Reader		
Pin No.	Symbol	Description
1	N C	
2	R x DB	Receive data from bar code reader
3	N C	
4	N C	
5	N C	
6	N C	
7	GND	Ground
8	N C	
9	VDD	

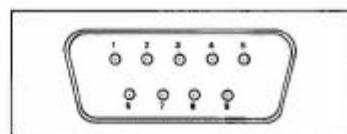

*40 Pin External
Bus Signal Interface*

40 Pin External Bus Signal			
Pin No.	Signal	Pin No.	Signal
1	VDD	40	VDD
2	GND	39	GND
3	ADO	38	AD1
4	AD2	37	AD3
5	AD4	36	AD5
6	AD6	35	AD7
7	A8	34	A9
8	A10	33	A11
9	A12	32	A13
10	A14	31	A15
11	GND	30	GND
12	RD	29	WR
13	IO/M	28	S0
14	ALE	27	S1
15	CLK	26	CE for I/O Cont.
16	RD +WR	25	RESET out
17	INTR	24	INTA
18	GND	23	GND
19	RAM RESET	22	N C
20	N C	21	N C

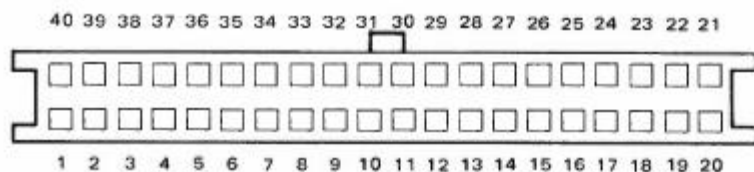

*Reference F/
TELCOM Codes*

This reference lists all the codes that TELCOM can send and receive. It contains 3 tables. The first table lists 128 ASCII codes, the second lists 128 ASCII extension codes, and the third lists sequence codes.

In each table: Column 1 lists the codes in decimal notation, Column 2 lists the codes in hexa-

decimal notation, Column 3 lists the codes in binary notation, Column 4 gives TELCOM's interpretation of a code received from the other computer, and Column 5 gives the keyboard character that you need to press to send a code to the other computer. (The third table does not include Column 3.)

Table 1. ASCII Codes

Decimal	Hex	Binary	Printed Character	Keyboard Character
0	00	00000000		(CTRL) ␣
1	01	00000001		(CTRL) A
2	02	00000010		(CTRL) B
3	03	00000011		(CTRL) C
4	04	00000100		(CTRL) D
5	05	00000101		(CTRL) E
6	06	00000110		(CTRL) F
7	07	00000111	bell	(CTRL) G
8	08	00001000	backspace	(CTRL) H
9	09	00001001	tab	(CTRL) I
10	0A	00001010	line feed	(CTRL) J
11	0B	00001011	cursor home	(CTRL) K
12	0C	00001100		(CTRL) L
13	0D	00001101	carriage return	(CTRL) M
14	0E	00001110		(CTRL) N
15	0F	00001111		(CTRL) O
16	10	00010000		(CTRL) P
17	11	00010001	XON	(CTRL) Q
18	12	00010010		(CTRL) R
19	13	00010011	XOFF	(CTRL) S
20	14	00010100		(CTRL) T
21	15	00010101		(CTRL) U
22	16	00010110		(CTRL) V
23	17	00010111		(CTRL) W
24	18	00011000		(CTRL) X
25	19	00011001		(CTRL) Y
26	1A	00011010	EOF	(CTRL) Z
27	1B	00011011		(ESC)
28	1C	00011100		→
29	1D	00011101		←
30	1E	00011110		↓
31	1F	00011111		↑
32	20	00100000		(SPACEBAR)
33	21	00100001	!	!
34	22	00100010	"	"
35	23	00100011	#	#
36	24	00100100	\$	\$
37	25	00100101	%	%

Decimal	Hex	Binary	Printed Character	Keyboard Character
38	26	00100110	&	&
39	27	00100111	'	'
40	28	00101000	((
41	29	00101001))
42	2A	00101010	*	*
43	2B	00101011	+	+
44	2C	00101100	,	,
45	2D	00101101	-	-
46	2E	00101110	.	.
47	2F	00101111	/	/
48	30	00110000	0	0
49	31	00110001	1	1
50	32	00110010	2	2
51	33	00110011	3	3
52	34	00110100	4	4
53	35	00110101	5	5
54	36	00110110	6	6
55	37	00110111	7	7
56	38	00111000	8	8
57	39	00111001	9	9
58	3A	00111010	:	:
59	3B	00111011	;	;
60	3C	00111100	<	<
61	3D	00111101	=	=
62	3E	00111110	>	>
63	3F	00111111	?	?
64	40	01000000	@	@
65	41	01000001	A	A
66	42	01000010	B	B
67	43	01000011	C	C
68	44	01000100	D	D
69	45	01000101	E	E
70	46	01000110	F	F
71	47	01000111	G	G
72	48	01001000	H	H
73	49	01001001	I	I
74	4A	01001010	J	J
75	4B	01001011	K	K

Decimal	Hex	Binary	Printed Character	Keyboard Character
76	4C	01001100	L	L
77	4D	01001101	M	M
78	4E	01001110	N	N
79	4F	01001111	O	O
80	50	01010000	P	P
81	51	01010001	Q	Q
82	52	01010010	R	R
83	53	01010011	S	S
84	54	01010100	T	T
85	55	01010101	U	U
86	56	01010110	V	V
87	57	01010111	W	W
88	58	01011000	X	X
89	59	01011001	Y	Y
90	5A	01011010	Z	Z
91	5B	01011011	[[
92	5C	01011100	\	GRAPH-
93	5D	01011101]]
94	5E	01011110	-	-
95	5F	01011111	_	_
96	60	01100000	\	GRAPH[
97	61	01100001	a	A
98	62	01100010	b	B
99	63	01100011	c	C
100	64	01100100	d	D
101	65	01100101	e	E
102	66	01100110	f	F
103	67	01100111	g	G
104	68	01101000	h	H
105	69	01101001	i	I
106	6A	01101010	j	J
107	6B	01101011	k	K
108	6C	01101100	l	L
109	6D	01101101	m	M
110	6E	01101110	n	N
111	6F	01101111	o	O
112	70	01110000	p	P
113	71	01110001	q	Q
114	72	01110010	r	R

Decimal	Hex	Binary	Printed Character	Keyboard Character
115	73	01110011	s	S
116	74	01110100	t	T
117	75	01110101	u	U
118	76	01110110	v	V
119	77	01110111	w	W
120	78	01111000	x	X
121	79	01111001	y	Y
122	7A	01111010	z	Z
123	7B	01111011	{	[GRAPH] 9
124	7C	01111100		[GRAPH] _
125	7D	01111101	}	[GRAPH] 0
126	7E	01111110	~	[GRAPH]]
127	7F	01111111		[DEL]

Table 2. ASCII Extension Codes

Decimal	Hex	Binary	Printed Character	Keyboard Character
128	80	10000000	☞	(GRAPH) p
129	81	10000001	♁	(GRAPH) m
130	82	10000010	(x	(GRAPH) f
131	83	10000011	ℓ	(GRAPH) x
132	84	10000100	⚙	(GRAPH) c
133	85	10000101	⚙	(GRAPH) a
134	86	10000110	♁	(GRAPH) h
135	87	10000111	♁	(GRAPH) t
136	88	10001000	π	(GRAPH) l
137	89	10001001	√	(GRAPH) r
138	8A	10001010	≠	(GRAPH) /
139	8B	10001011	Σ	(GRAPH) s
140	8C	10001100	≈	(GRAPH) '
141	8D	10001101	±	(GRAPH) =
142	8E	10001110	∫	(GRAPH) i
143	8F	10001111	◀	(GRAPH) e
144	90	10010000	♁	(GRAPH) y
145	91	10010001	♁	(GRAPH) u
146	92	10010010	↕	(GRAPH) ;
147	93	10010011	♁	(GRAPH) q
148	94	10010100	♁	(GRAPH) w
149	95	10010101	♁	(GRAPH) b
150	96	10010110	♀	(GRAPH) n
151	97	10010111	%	(GRAPH) .
152	98	10011000	↑	(GRAPH) o
153	99	10011001	↓	(GRAPH) .
154	9A	10011010	→	(GRAPH) l
155	9B	10011011	←	(GRAPH) k
156	9C	10011100	⊕	(GRAPH) 2
157	9D	10011101	◊	(GRAPH) 3
158	9E	10011110	♡	(GRAPH) 4
159	9F	10011111	♠	(GRAPH) 5
160	A0	10100000	ˆ	(CODE) ^
161	A1	10100001	à	(CODE) z
162	A2	10100010	ç	(CODE) f
163	A3	10100011	£	(GRAPH) 8
164	A4	10100100	˘	(CODE) "
165	A5	10100101	μ	(CODE)]

Decimal	Hex	Binary	Printed Character	Keyboard Character
166	A6	10100110	ˆ	(CODE)
167	A7	10100111	˘	(CODE) _
168	A8	10101000	†	(CODE) +
169	A9	10101001	‡	(CODE) s
170	AA	10101010	Ⓜ	(CODE) R
171	AB	10101011	Ⓝ	(CODE) Y
172	AC	10101100	¼	(CODE) p
173	AD	10101101	½	(CODE) :
174	AE	10101110	¾	(CODE) /
175	AF	10101111	¶	(CODE) 0
176	B0	10110000	⌘	(GRAPH) 7
177	B1	10110001	A	(CODE) Q
178	B2	10110010	Ô	(CODE) O
179	B3	10110011	Ù	(CODE) U
180	B4	10110100	€	(GRAPH) 6
181	B5	10110101	˜	(CODE)
182	B6	10110110	à	(CODE) q
183	B7	10110111	ó	(CODE) o
184	B8	10111000	û	(CODE) u
185	B9	10111001	β	(CODE) S
186	BA	10111010	ı	(CODE) T
187	BB	10111011	é	(CODE) d
188	BC	10111100	ú	(CODE) m
189	BD	10111101	ë	(CODE) c
190	BE	10111110	-	(CODE) -
191	BF	10111111	ƒ	(CODE) F
192	C0	11000000	á	(CODE) 1
193	C1	11000001	â	(CODE) 3
194	C2	11000010	ı	(CODE) 8
195	C3	11000011	ó	(CODE) 9
196	C4	11000100	û	(CODE) 7
197	C5	11000101	-	(CODE) -
198	C6	11000110	e	(CODE) e
199	C7	11000111	ı	(CODE) l
200	C8	11001000	a	(CODE) a
201	C9	11001001	ı	(CODE) k
202	CA	11001010	o	(CODE) l
203	CB	11001011	ú	(CODE) j
204	CC	11001100	ı	(CODE) i

Decimal	Hex	Binary	Printed Character	Keyboard Character
205	CD	11001101	ñ	(CODE) n
206	CE	11001110	â	(CODE) v
207	CF	11001111	ô	(CODE) b
208	D0	11010000	Æ	(CODE) X
209	D1	11010001	æ	(CODE) x
210	D2	11010010	Ä	(CODE) W
211	D3	11010011	ä	(CODE) w
212	D4	11010100	ø	(CODE) >
213	D5	11010101	ø	(CODE) .
214	D6	11010110	ñ	(CODE) N
215	D7	11010111	É	(CODE) D
216	D8	11011000	À	(CODE) A
217	D9	11011001	Í	(CODE) K
218	DA	11011010	Ó	(CODE) L
219	DB	11011011	Û	(CODE) J
220	DC	11011100	¿	(CODE) ?
221	DD	11011101	Ü	(CODE) M
222	DE	11011110	È	(CODE) C
223	DF	11011111	Á	(CODE) Z
224	ED	11100000		(GRAPH) Z
225	E1	11100001	■ (upper left)	(GRAPH) !
226	E2	11100010	■ (upper right)	(GRAPH) @
227	E3	11100011	■ (lower left)	(GRAPH) #
228	E4	11100100	■ (lower right)	(GRAPH) \$
229	E5	11100101	■	(GRAPH) %
230	E6	11100110	■	(GRAPH) ^
231	E7	11100111	— (upper)	(GRAPH) Q
232	E8	11101000	— (lower)	(GRAPH) W
233	E9	11101001	(left)	(GRAPH) E
234	EA	11101010	(right)	(GRAPH) R
235	EB	11101011	■	(GRAPH) A
236	EC	11101100	■	(GRAPH) S
237	ED	11101101	■	(GRAPH) D
238	EE	11101110	■	(GRAPH) F
239	EF	11101111	■	(GRAPH) X
240	F0	11110000	ˆ	(GRAPH) U
241	F1	11110001	—	(GRAPH) P
242	F2	11110010	ˆ	(GRAPH) O
243	F3	11110011	ˆ	(GRAPH) I

Decimal	Hex	Binary	Printed Character	Keyboard Character
244	F4	11110100	┌	GRAPH: J
245	F5	11110101		GRAPH: :
246	F6	11110110	└	GRAPH: M
247	F7	11110111	┘	GRAPH: >
248	F8	11111000	┐	GRAPH: <
249	F9	11111001	└	GRAPH: L
250	FA	11111010	+	GRAPH: K
251	FB	11111011	▀	GRAPH: H
252	FC	11111100	▄	GRAPH: T
253	FD	11111101	▀	GRAPH: G
254	FE	11111110	▄	GRAPH: Y
255	FF	11111111	▣	GRAPH: C

Table 3. ASCII Sequence Codes

Decimal	Hex	Keyboard Character	Printed Character
27,65	1B,41	(ESC)A	Move cursor up one line.
27,66	1B,42	(ESC)B	Move cursor down one line.
27,67	1B,43	(ESC)C	Move cursor right one space.
27,68	1B,44	(ESC)D	Move cursor left one space.
27,69	1B,45	(ESC)E	Clear display.
27,72	1B,48	(ESC)H	Home cursor (moves cursor to top left corner).
27,73	1B,49	(ESC)I	Answerback.*
27,74	1B,4A	(ESC)J	Erase to end of scree.
27,75	1B,4B	(ESC)K	Erase to end of line.
27,76	1B,4C	(ESC)L	Insert line.
27,77	1B,4D	(ESC)M	Delete line.
27,80	1B,50	(ESC)P	Turn cursor on.
27,81	1B,51	(ESC)Q	Turn cursor off.
27,84	1B,54	(ESC)T	Set system line.
27,85	1B,55	(ESC)U	Reset system line.
27,86	1B,56	(ESC)V	Disable video.
27,87	1B,57	(ESC)W	Enable video.
27,89 <i>r,c</i>	1B,59 <i>r,c</i>	(ESC)Y <i>r,c</i>	Move cursor to specified row/column position.
27,106	1B,6A	(ESC)Z	Clear screen.
27,108	1B,6C	(ESC)[Erase entire line.
27,112	1B,70	(ESC)P	Enter reverse video mode.
27,113	1B,71	(ESC)Q	Exit reverse video mode.

* The answerback code sequence is for communication purposes. When the Tandy 102 receives this code sequence from the other computer, it responds by sending back a few words that identify what kind of terminal it is.

Index

- (BREAK)** 12
- (CODE)** 117
- (DEL)** *See* TEXT
- (GRPH)** 117
- (LABEL)** 16
- (PASTE)** *See* TEXT
- (PRINT)** *See* Printer
- Acoustic coupler 46, 90
- Add-ons 34
- ADDRSS 23
- ASCII codes 81, 128
- Asynchronous transmission 81
- Autodialing 25
- Auto power-off 122
- Backspace 104
- Bar code reader 34
- Bar code reader interface 124
- BASIC
 - Help 112
 - Running a program 30
 - Sample programs 120
 - Saving a program 30
 - Transferring files 106
- Batteries 3
- Baud
 - Setting 86
 - TELCOM convention 78
- Bits per second (bps) *See* Baud
- Built-in modem *See* modem
- Codes
 - ASCII 81, 128
 - Other 82, 132
 - Sending control codes 104
 - Sequence 81, 136
- Bytes 5
- Cassette interface 123
- Cassette recorder *See* Tape
- Clock 6
- Cold restart 122
- CompuServe
 - Accessing 48
 - Autologon sequence 71
 - EMAIL 62
 - Retrieving information 55
 - Sending electronic mail 41, 60
 - Using pages 57
- Connection
 - Built-in modem 89-93
 - Bulletin board 65
 - Cable (RS-232) 95
 - External modem 99
 - Public-access computer 39-43
- Converting files
 - BASIC files 106
- Copying
 - Files 18
 - Text 18
- Datapac 40-42
- Date, entering 6
- Day, entering 6
- Deleting files 19
- Dialing *See* Autodialing
- Disk drive 34
- Dow Jones
 - Autologon sequence 71
 - Accessing 49
 - Subscribing 41
- Electronic Mail 43,61
- External Bus signal
 - interface 126
- External modem *See* modem
- Files
 - Copying 18
 - Deleting 19
 - Renaming 19
 - Transferring 105-107

- Full duplex 104
- Half duplex 104
- Help 109-115
- Host computer 78
- Library Services 43
- Main Menu 5
- Memory Power Switch 4, 6
- Modem
 - Connection, built-in 46, 95-98
 - Connection, external 99-102
 - Signals 78
- Networks, public 40
- News Services 43
- Parallel printer interface 123
- Parity
 - Meaning 81
 - Setting 87,52
- Power adapter 4
- Printer
 - Connections 7
 - Printer interface 124
 - Printing display 7
 - Printing a text file 11
- Private computers 75-107
- Problems *See* Help
- Public-access computers 37-73
 - Bulletin boards 65
 - Connecting 66
 - Disconnecting 67
 - Printing online information 59
 - Saving online information (download) 59
 - Seeing the previous screen 59
 - Sending information (upload) 63
 - Setting parameters 52
 - Subscribing 40
- Random access memory (RAM)
 - Description 5
 - Extra 34
- Read-only memory (ROM) 5
- Renaming files 19
- RS-232 79-80, 95-98, 101
 - Interface 123
- SCHEDL 22
- Sequence codes 81
- Specifications 122
- Stop bit
 - Meaning 81
 - Setting 87, 52
- Synchronous transmission 81
- Tape Recorder
 - Cassette interface 123
 - Connections 12
 - Loading text files 13
 - Protecting 13
 - Saving text files 12
- TELCOM
 - Autodialing numbers 25
 - Autologon sequences 69-73
 - Codes 127
 - Communication conventions 77-83
 - Connecting to CompuServe *See* CompuServe
 - Download 59, 105
 - Finding numbers 27
 - Help 113
 - Modem interface 125
 - RS-232 Interface 123
 - Parameters 52, 85
 - Previous screen 56, 104
 - Print 59, 104
 - Start/Stop 58, 87, 104
 - Upload 63, 105
- Telenet 40-42
- Telephone *See* Autodialing

- Telex Networks 43
- Terminal 78
- TEXT
 - Correcting mistakes 10
 - Creating a file 10
 - Cursor Movement Keys 16
 - Cutting text 17
 - Deleting text 11
 - Entering text 10
 - Finding text 17
 - Help 111
 - Pasting text 18
 - Printing 11
 - Repeating text 11
 - Saving to tape 12
 - Selecting text 17
- The Source
 - Accessing 51
 - Autologon sequence 71
 - Subscribing 42
- Time, entering 6
- Transmission 81
- Tymnet 40-42
- Uninet 42
- Word length
 - Meaning 81
 - Setting 52, 87

